

The NCTCUG Journal

www.nctcug.org

June/July 2002

Volume 25 Issue 4

Keeping Up

by Paul Howard (NCTCUG)

Well, another tax season's come and gone. Now you get to ponder the big questions, like "If I got a refund this year, rather than owed taxes, is that a good thing?" "Am I really better off with a refund, or with the capital gains of the previous tax year — you know, the one before the stock market dove into the white porcelain appliance?"

Tax time is always software upgrade time around my computer room. This year, I discovered that my system is truly out of date. Getting the Norton AntiVirus upgrade for 2002 along with the latest edition of TurboTax in the usual frenzy of package deals, I found that NAV 2002 wouldn't install on a system as ancient as mine (dating to June '98), because I was still running Windows 95 SR2. The 2002 NAV will only install when the OS is Win 98 or better, but it does include a copy of NAV 2001, which was compatible back to Win 95SR2. I'm still running Norton SystemWorks 3.0 from '99, and kept up to date by buying NAV virus definition subscriptions. I suppose the time is truly here to invest in a new system with updated system software.

If the upgrade throes of the NCTCUG demo computer are any indication, trying to upgrade a computer of '98 vintage with Windows XP may be an exercise in frustration, futility, and the refrain of Freddy Fender's "Wasted Days and Wasted Nights!" Attempts at installing Windows XP Professional on an AMD K6-400 yielded nothing, except several meetings where we sat around and watched the installation screen count down to "19 minutes remaining" before the system locked up. Conspiracy Theory: Would a vendor of operating systems insure the latest release wouldn't install on older systems? Would hardware manufacturers, on the ropes since the Tech slide, cheer such a development?



(Continued on page 14)

Inside

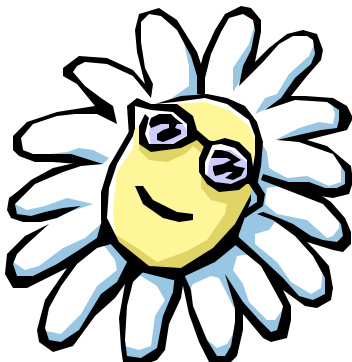

The Department of Homeland PC Security	page 2
The \$152 Internet Bargain.....	page 4
Ontrack SystemSuite 4.0.....	page 5
The New Windows XP — Is It All That It Is Claimed To Be?	page 7
My Favorite E-Mail Program	page 9
The Plain Truth about Casual Software Piracy.....	page 10
My Email Address Is Changing.....	page 13

The Department of Homeland PC Security

The Latest Maintenance And Protection Tools Safeguard Your Data

Patrick J. Suarez, pjsuarez@gemair.com

Former Pennsylvania governor Tom Ridge now heads a new federal department with the off-kilter title of the Department of Homeland Security, sort of evoking Aaron Copland's music and amber waves of grain. We all know why such a move became necessary.

Just as we now have to keep an eye on things around us in these United States, you must do likewise with your Windows-based PC. Think of computer security as a microcosm of the larger society in which your computer exists, with two fronts of defense against losing your precious data and your software's carefully cobbled-together configuration, what with patches and upgrades and all.

The first front of defense ironically involves protecting your data from the computer in which it resides. Let's begin with the fearsome registry, that chamber of horrors that holds information about your hardware and software and, if allowed to corrupt with a slowly mounting volume of incorrect or outdated entries, will bring about the demise of your entire system. Finally, someone has invented a program that corrects erroneous entries and removes unneeded data. It does so thoroughly and carefully. It scans every line of the registry and builds a list of wrong entries. It then sweeps this list to find new references in your system for the list's entries. In two mouse clicks, the whole registry is scrubbed clean. This wonder of wonders is Registry Healer 3.0 from www.zoneutils.com. It costs \$19.95, the best double sawbuck you ever spent.

Next, remove fragmentation, the tendency for data to break up into multiple pieces that scatter around your hard drive, with Diskkeeper Pro 7.0 from Executive Software (www.diskkeeper.com). The program runs \$45 as a download. Diskkeeper is the most honest defragger around; sometimes, even multiple passes won't completely defrag a drive. Diskkeeper shows you the before and after, and sometimes the after requires another pass or two. And then you might never get to 100% defragmentation. My son's computer has a 60-gigabyte hard drive, and it fragmented so terribly that Norton Utilities couldn't read it. Diskkeeper made some progress, but that drive is beyond even Diskkeeper's ability to put digital Humpty Dumpty back together again.

Moral of the story: *Defrag at least every other day.*

And then there are those stray DLL files that hang around long after you have removed an application from your system. DLL files sit in C:\Windows\System and act as code libraries for Windows programs.

Think of them as executive assistants to .EXE files, (e.g., word.exe). Word.exe needs an army of DLL files to help it do things like creating Word's screen images with which you are so familiar. It also needs them to help it perform actions (e.g., saving files, etc.). The popular "disk cleanup" programs you see on store shelves no longer seek and destroy old DLLs. But AnalogX's DLLArchive does. Actually, DLLArchive stores DLLs it removes from C:\Windows\System in another directory. Once you are absolutely certain that the DLLs that DLLArchive has banished are no longer needed, you can empty that folder (C:\Windows\DLLArchive). Final note: I do recommend Norton's Clean Sweep. It does safely rid your hard drive of unneeded files that build up during Web browsing. Get Clean Sweep at any store that sells software.

Add a final touch with DiskPie, an application from www.pcmag.com that tells you which programs are hogging your drive.

Voila! You've gained back hard drive room and rid your system of stuff it doesn't need and could get you into trouble. And, I'm going to make a statement that I swear is true: Since I have been using the products described above, I have had no problems, none, with Windows ME. It has been as solid as a rock. No kidding. What better endorsement can I give these programs than that?

Let's move on to the other PC defense front, protecting your data from outside influences. First, stop using Microsoft Outlook. Because there are none so deaf as those who will not hear, I'm going to be pushy and obnoxious in the rest of this paragraph. It's the only way I can get through to those who need to read this. Ready? I know that there are obstinate corporate wanks out there who overglorify this deadly program, and they do so with a certain level of stuffy arrogance. Fine. You people are exactly the problem: every virus writer in the world writes to Outlook's well-known (and permanent) design flaws. But the Microsoft mindset is a wondrous thing to behold, so you folks will continue to gather and spread viruses at

unprecedented rates. Here's a news flash: there are alternate programs out there that work just as well and that do not help the spread of malicious e-mail code. OK, that's off my chest, and it ought to generate a certain level of e-mail traffic to the editor and publisher of this newsletter. At least I hope so.

You need firewall software, a Trojan horse sniffer, and an effective antivirus program. This is such well-trodden territory that I won't reiterate the obvious. I will tell you that my favorite trio of protection in this arena is ZoneAlarm Pro (finally, thank heavens, available on retail software shelves everywhere); Trojan Remover from www.simplysup.com (\$24.95); and Norton Antivirus 2002, newly redesigned with the smartest antivirus engine that automatically grabs updates from its home Web site. I've tried them all and Norton gets my vote. ZoneAlarm Pro, by the way, makes my Windows based computers totally invisible to everything on the Internet.

Essentially, my PCs can see the world, but the world has no idea that my PCs even exist.

Go one more mile, then, and visit www.scumware.com. Download and run AdAware, Surf+ and Gator. These programs remove spyware from your system. Spyware is insidious code planted by advertisers in your registry and Windows folder. This, friends, is going to be a big deal in Congress as users face off against marketing muscle. These guys want to climb into your wallet, psyche and soul, and they'll stop at nothing in terms of Web bugs and bots to get there. Be on your guard. Tell them to take a hike.

I find it sad that we must invest so much time and energy into protecting us from each other. What a glorious tool the computer continues to be. But with good comes evil, and you have to gird your digital loins against the world that exists past your firewall.

I leave you with a few thoughts. First, sometimes these programs can give you wrong information, but it's easy to tell when they do. I tried to install the new Real One, the latest edition of Real Audio, into my Windows ME computer. After installation, Real One would not open. So, I tried to use Add/Delete Programs and the uninstaller failed. I manually extricated the program from my hard drive and registry. When I ran DLL Archive, it found 1,700 DLL files suddenly orphaned. Registry Healer found 1,548 registry errors. Clearly, this was nonsense and you learn what to trust and what not to trust with these programs. The installation and forced re-

moval of Real One tipped my Windows ME over the edge and into the Chasm of Registry Oblivion. I reformatted the drive and installed, *gasp!*, Windows XP. Since I had not installed a new operating system on that drive in years (Windows 95 became Windows 98 which became Windows ME), it was time to rebuild everything from scratch. Real One was the program that finally did my system in.

Second, all of the programs I described in this article are for protection in the Windows environment. On my Linux computer, I need none of this.

And I rarely have a problem. Now, as they say, "*pila in area tua est*". [If Caesar were alive today, he'd translate that to "the ball is in your court".] Go forth and conquer your system.

Patrick J. Suarez, a member of the Dayton Microcomputer Assn. Inc. is a nationally recognized Internet writer, trainer, speaker and consultant. He has appeared on numerous radio and TV programs across the United States. He is the Internet speaker at DMA's semi-annual Computerfest trade show in Dayton, OH each spring & fall.

Mr. Suarez published a tutorial software program called "The Beginner's Guide to the Internet" in 1993, and a book by the same title followed in 1995. In addition,

Mr. Suarez has been published by Que. Mr. Suarez operates a Web site supporting people who have just learned that they have a tumor. He has just completed a project with Qwest Communications in Dublin, Ohio, as a Senior Technical Communicator.



The \$152 Internet Bargain

When to decide if a trip to Target is a better bet

By Steve Bass, Pasadena IBM Users Group

I don't have a good head for numbers, so double-check these figures for me, okay? I went online, pressed a few buttons, and two minutes later, bought a bottle of multivitamins for \$10 and some Folic Acid for \$3. Shipping was \$3 so the entire bill was \$16, right?

Nope. It cost me closer to \$152 and two hours of futzing.

Raise your hand if you think shopping on the Internet can save you money. No doubt it can, provided you use it efficiently.

In the next few minutes, I'll show you the mistakes I've made (hey, I'm not as bright as I look, okay?), how you can avoid them, and maybe stave off a few gray hairs in the process.

Bargain Hunting

The trap I always seem to fall into is spending a few minutes trying to find the best deal on the Internet. (Computing minutes, as you may have noticed, are not related to real minutes, but that's another story.) I started by opening my Internet Explorer Favorites and trying to remember which folder I tucked the "vitamins and drugs" into.

Oddest thing, I muttered, is how these darn Favorites have a way of getting disorganized. I mean, what was I thinking when I combined DVD Rentals and DVD Player Research into the same folder. That's confusing, even to me, and it might be best if I separated them into two folders. I wouldn't take five minutes to fix. You think?

Of course, an interesting thing happened while cleaning and dusting my Favorites. I noticed the "Free Stuff" folder, the one with coupons, discounts, and giveaways. Right, I think, I'd better stop by there first and see if Drugstore.com or MotherNature.com is offering free shipping. My first stop is to couponsforyou.com. Nothing for me there because it's a dot.gone. So were four other coupon sites. I hit the jackpot with www.dealofday.com because drugstore.com offered free shipping and a free diaper travel bag with any \$20 order. Cool, I could use the diapers for buffing the car and I'd find something to do with the bag. And free shipping will put \$4.95 in my pocket.

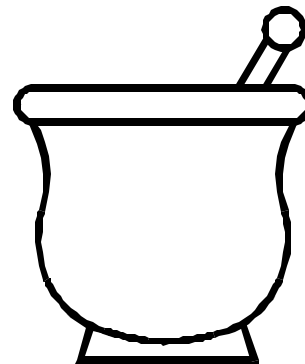

So What's The Deal?

The deal wasn't difficult to handle. Do all your shopping, stick the code into the special box on checkout, and shipping was deducted from the total. I did all my shopping, clicked done, and drugstore.com gleefully greeted me. "Yo! Steve-o! Welcome back buddy. Good to see you! But listen, the free shipping, and diaper deal? New customers only. Sorry, pal." *Busted.*

I couldn't just let that go. It was a challenge to my hacker mentality and less-than-adequate hacking skills. Creating a new user name and account couldn't be much work, and drugstore.com wouldn't be the wiser. I really wanted that diaper bag.

Busted Again

"Hey, Frank, when did you move in with Bass?" Around ten this morning, I fumed. It was a good question and one that I felt drugstore.com had no right to ask. As a consenting adult, what I did with my alias is my business.

I was busted again and chose not to play around with drugstore.com's cookies. So I headed back to AdvanceRX's site, added three bottles of Folic Acid to AdvanceRX's shopping cart. But it hit me that Drugstore.com was selling it in bottles of 200 tablets, a better deal. I think. But hell, even if I paid for shipping and went without the diaper bag, that'd save me roughly \$2. Better check.

So I open a fourth browser window, navigate to the site, and find I was right the first time. Advance RX is the best deal. You know, Bass, I think, kicking myself. You oughta stick this stuff on a spreadsheet so next time you can refer back to it. Easy enough to do, so I do a few rows and columns, stick in sites, vitamins, prices, shipping, and whether I've ordered there before. It was worth the 35 minute investment, really, even though I decided to forego any fancy fonts or formatting.

Software Review

Ontrack SystemSuite 4.0

By Herb Goldstein, Sarasota Personal Computer Users Group, Inc.

Reprinted from the Sarasota PC Monitor, December 2001

Right after you install an operating system, the very next thing you ought to look into is an all-purpose utility-software that will find, fix and prevent problems on your computer. It is true that Windows 98 and now XP have brought along their own set of utilities that have been successively broadened and strengthened, but they are still significantly surpassed by the capabilities of today's utility suites. And which of those is best? Look no further. Get yourself a copy of Ontrack's System Suite 4 (SS4).

SS4 will do almost everything but paint your computer blue. It has a sizable collection of applets that combine to offer you the most and some of the best utilities available today to keep your computer running properly and prevent problems. It is an immensely powerful and extremely popular program that truly belongs on your computer. Although SS3 is still the powerhouse it was, some new features have been added for Version 4:

- 📁 Net Defense — A personal firewall to keep you hacker-free.
- 📁 Specialized Fix Wizards — One stop solutions to speed up, clean up and fix up. A single click does it all.
- 📁 Auto Email Scan — Protect your email inbox from viruses, worms, etc.
- 📁 Clock Sync — Synchronizes your computer's clock with the super-accurate Atomic Clock.
- 📁 Error Tracker — Logs error messages to help diagnose problems.
- 📁 Desktop Shortcuts — Drag a shortcut of any utility in the suite to your desktop for easy access.

Stay Calm, Okay?

By now I'm feeling a little antsy so I head back to AdvanceRX to place the order and get on with my life. At this point, you're probably one step ahead of me. I faced a really dumb problem: After all my futzing elsewhere, AdvanceRX timed out. The shopping cart was empty, my patience was fading, and I was in dire need of a psychotropic drug. Try clicking IE's Back button, I thought and Windows applauded my decision with a General Protection Fault. With all the B vitamins I'd depleted, I didn't think it made sense to bother rebooting.

I asked my wife if she'd like to make a quick trip to Costco. She did, we found the vitamins (about \$2 more than online, not including the stress formula I felt a need to buy); we also bought \$100 of stuff we really didn't need and went out for lunch.

Next month? Shopping Tips for Internet Shopaholics.

Steve Bass is a Contributing Editor with PC World and runs the Pasadena IBM Users Group. He's also a founding member of APCUG Write to him at Steve_bass@pcworld.com. Check PCW's current edition at <http://www.pcworld.com/resource/toc/index.asp> and sign up for the Steve Bass online newsletter

FIX-IT UTILITIES lies at the very heart of the matter. It is available as a stand alone program that contains the lion's share of what is available in the suite, but distributed under different headings. The current version of this super-utility, 4.0, is not radically different from the previous, but has been enhanced for compatibility with Windows XP.

The individual utilities of the suite fall under 8 major headings, a list of which is visible when you enter the suite. They and their contents are as follows:

One Stop Solutions — A single click on any of the buttons mentioned below will activate a series of diagnostic and repair steps to find and fix problems:

1. SPEEDUP — Will defragment and optimize your hard drive so that programs you use most frequently will cluster in the fastest area of your drive. Intellicluster will monitor your computer usage to determine what you use more frequently.
2. FIXUP — Will diagnose and repair system problems.

(Continued on page 6)

(Continued from page 5)

3. CLEANUP — Clear out unnecessary files to regain space. It will, of course, ask you first.
4. ALL-IN-ONE — Does the 3 above steps at one fell swoop.

Firewall NETDEFENSE is SS4's utility to keep you free of hackers and intruders. It is equally as effective as ZoneAlarm, but has a number of enhancements that make it easier to understand and work with. It also keeps a Net-Defense Log which is more powerful, sophisticated and organized a good deal more intelligently, and permits you to trace a hacker. The core of the program is written by SyGate, a recognized expert in the field. I tested NetDefense out with GRC's "Shields Up" and port probes. It passed all with flying colors and made my computer completely invisible to intrusion attempts.

Optimize And Maintain

1. JET DEFRAG — Quickly defragment and optimize your hard drive.
2. CLOCK SYNC — Synchronize your clock with the ultra-accurate atomic clock.
3. SIZE MANAGER — Finds the files and folders that are cluttering up your system and provides options for control.
4. DATA ERASER — Permanently erase files from your hard drive so they can't be recovered.
5. REGISTRY DEFRAG — Defragment your registry for faster operation.
6. SYSTEM SCHEDULER — Schedule various utility tasks for automatic operation.
7. REGISTRY EDITOR — Find and edit registry items and settings.

Diagnose

1. PC DIAGNOSTICS — Diagnose hardware problems
2. SYSTEM EXPLORER — See what's happening in your system right now.

3. SMART DEFENDER — Monitors your hard drive and provides an early failure warning.
4. SYSTEMLOG — Logs System Suite's functions.
5. ERROR TRACKER — Tracks and records Windows error messages.
6. DISK VERIFIER — Determines if a disk or CD can be read without errors.
7. SYSTEM MONITORS — Tracks and provides a continuous or instant readout of system resources, CPU usage, threats, memory load, and virtual memory parameters.

Fix

1. DISK FIXER — Diagnose and fix disk problems.
2. CRASH PROOF — Stops Windows crashes.
3. EASY UPDATE — Downloads program updates and new virus pattern files.
4. REGISTRY FIXER — Finds and fixes errors in your registry.
5. SYSTEM UPDATES — Scans for updates to the other programs on your computer.

Recover SS4 provides a number of applets that will recover accidentally deleted files and data. It includes a stand-alone program, Easy Recovery, which is strong enough to recover files that have been damaged by viruses or eliminated by computer malfunctions. It will also undo changes made by SS4, and creates a rescue disk for booting an otherwise unresponsive system.

Uninstall

Monitors your installations of programs so that a subsequent uninstallation will remove all the bits and pieces that were installed in your registry and everywhere else on your computer. Also can build a database of programs already installed and will search out where the elements of those are located for accurate uninstallation. Of the several uninstaller utilities, this is the only one I have found that really does the job.

Uninstaller will also move an application from one partition to another in total, and changes all the registry settings to reflect its new location. It will further transport programs in

total from one computer to another without your needing to reinstall that program. All the upgrades and tweaks which you may have inserted in that program will go along with it.

A backup and restore feature is also provided that will permit you to reinstall an uninstalled program if you change your mind.

Cleanup

A number of applets in this section will cleanup the junk that accumulates on your computer such as your temporary Internet files, Internet history, active X files, cookies, recycle bin, history, Internet plug-ins, and unnecessary registry entries.

Several other stand-alone applications are also incorporated into System Suite. You will find the major elements of ZipMagic in SS4. Zip and unzip files and send a zipped file out by e-mail, and more. Perhaps the star of the included apps is Ontrack's Power Disk. It alone is worth the cost of SS4. It is a unique and absolutely superb file manager. Think of it as Windows Explorer on steroids. It will do almost every common, and many uncommon tasks to files and folders that you will find yourself using constantly.

Crisis intervention for serious problems that may prevent you from booting up or getting into Windows is provided on the installation CD and an accompanying emergency disk, in addition to one you create when installing SS4.

A "rare these days" excellent manual is provided with SS4. It is very inclusive, easy to read and understand, and will guide you through the use of each of the many of the suite's utilities. It is matched only by the top-notch help files you can access from within the program. It is difficult to say enough about SS4 except "WOW!" What it provides is truly staggering and gives new meaning to the term "utility suite." It is available at a street price of about \$50. Don't hesitate!

© 2001

www.ontrack.com

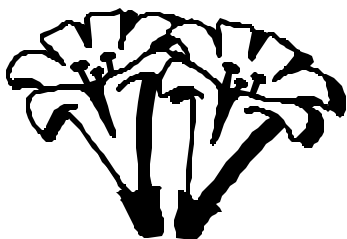

The New Windows XP — Is It All That It Is Claimed To Be?

By Ira Wilsker, Golden Triangle PC Club

Reprinted from the I/O Port Newsletter, Tulsa Computer Society

For the past few weeks, we have been bombarded with ads for the new Windows XP. Windows XP has been available on new computers for several weeks, and the newly released retail upgrade versions for home and office use are now on the market. While reviews of Windows XP have shown some marked advantages, especially its resistance to "fatal errors", and the ability to shut down one crashed program without requiring the rebooting of the computer, there are still some very controversial issues with XP that may warrant some consideration before spending about \$100 to upgrade from an earlier Windows version to XP.

Much of the technical computer press has had the opportunity to thoroughly evaluate XP. It is slick in appearance, and has a fresh new look and feel. It can better perform many functions than earlier Windows versions. It is designed to be more secure than 98, ME, NT, or 2000, with many security holes patched. Microsoft claims that XP is ready to handle the latest hardware and software technologies on the market, and Microsoft is mostly correct.

As is typical with Microsoft, any major new software release is wrought with controversy, and XP is no different. One of the first issues is Microsoft's anti-piracy effort. While it has always been illegal, it was very common for individuals to purchase one retail copy of the Windows upgrade version, and install the software on more than one computer at home, such as a desktop and a notebook. While discouraging the practice, as it deprived Microsoft of sales revenues, Microsoft tended to look the other way. This illegal, but widely accepted software piracy, helped make Windows the standard that it has become.

With XP each retail copy can be installed on only one machine. Microsoft now requires an activation code for each copy of XP; if the software is not activated by phone or online, it will cease to function after 30 days. The activation key is generated by taking a snapshot of the key hardware components in the computer, and generating a large, coded number. This is matched against an embedded code in the software, and a unique key is generated. While it does indeed prevent installation on more than one computer, it creates other problems for the home or small office

(Continued on page 8)

(Continued from page 7)

user. If more than a few items in the computer are upgraded, such as adding memory, changing the video card, or any of many normal hardware changes, the key will change, and XP may cease to function, requiring another call to Microsoft.

As stated earlier, XP includes several new security enhancements, intending to make it more secure against hackers while online. XP includes a firewall. Published tests indicate that while the XP firewall is less effective than most of the third party firewalls on the market, including the free ones like Zone Alarm, it also interferes with and blocks some of the other integral XP features, such as instant video messaging, and remote support. It is expected that in typical Microsoft fashion, a "service pack" will be released to address these bugs.

With the explosive use of wireless networking, XP includes integral wireless network support complying with the 802.11b standard. Tests in the computer press however indicate that while XP is designed to seamlessly integrate with wireless networks, many major makers of 802.11b hardware still do not have fully functional drivers for XP. Though the equipment may work flawlessly with Windows 98 or 2000, it often fails to function properly with XP.

The issue of hardware drivers, basically proprietary programs that make hardware work with software, is another current weakness of XP that will eventually be resolved. Many hardware makers do not yet have drivers for XP. Without those drivers, the hardware, such as scanners, modems, video cards, etc., will not properly function, or not function at all. While most of the major makers currently have or are preparing XP drivers for their current hardware, (the XP install disk contains a large library of drivers), much older hardware still in wide use will receive XP drivers either at a later date, or not at all. With the recent massive shakeout in the computer industry, there are many fine products still in wide use for which their manufacturers are out of business; it is highly unlikely that XP drivers will ever be available for these products.

XP is also a memory and resource hog. Tests indicate that 256megs of memory should be a minimum. Since most memory is currently cheap, adding memory before installing XP may be a good idea for many. XP will do everything possible to get users to register for Microsoft's ".Net Passport" and Hotmail services. While ".Net Passport" is currently free, a MS executive has been widely quoted in the press (and it is in the license agreement) that MS may charge a monthly fee in the future. Pundits sug-

gest that users get the "passport.com" email account rather than the Hotmail account.

MSN plans to sell advertising to reach its registered XP users, and the default is "opt-in". Reports indicate that MS has already signed up over 300 vendors who will access the registration lists. There is no single "opt-out" method to stop all of the "spam" advertising, but MS will allow the user to opt-out individually to each advertiser.

MP3 has become a popular music format, with literally millions of users using the format for a variety of purposes. In order to avoid MP3 licensing fees, XP dropped built in MP3 support. A "fee-based" plug-in for the built in Windows Media Player is available. A variety of third party MP3 players are also available, but MS is trying to encourage the promotion of its own Windows Media format, rather than the current MP3 standard.

The entire system overhead comes with a performance price. In identical machines, when compared with Windows 2000, testing shows that XP is 25%-30% slower in performing the same tasks, while consuming significantly greater resources. One other possible source of inferior performance may be the default settings created by XP, which defaults to the older ATA/66 hard drive speed, rather than the faster ATA/100 common on most newer hard drives. If your computer is more than a few months old, and seems to work okay with Win98, NT, or 2000, there is no pressing need at present to switch to the newer XP. Save your money or add more memory or a faster hard drive. This may be a better way to improve your performance than spending money on XP.



My Favorite E-Mail Program

by Sigrid Foreman, Tyler Computer Club email sigrid@tyler.net

Many of us use e-mail on a daily basis and we use different e-mail programs depending on what we want from it. Here are a few that are available.

Free Programs...such as Juno do not require you to have an internet account with anyone. They simply let you send and receive e-mail (including attachments) without any internet surfing. This means that you have no monthly or hourly charge to worry about. E-mail programs that require an Internet account... this is what most of use, be it thru providers like AOL, Prodigy, MSN or an independent internet provider such as Gower, Ballistic, Flashnet, Cox-Internet etc.. where you would use programs such as Outlook Express, Netscape Messenger, Eudora or my favorite Incredimail.

<http://www.incredimail.com/>

Many of you have not heard of it, and I would like to take this opportunity to speak a little about it. Incredimail is provided to you free of charge...unless you choose to get the full program (\$29), which basically provides support (which I have used and is pretty good) and allows you to preview your messages on the server prior to you downloading them. It comes with a demo program of Letter Creators (you're allowed to make 1-3 letters before you have to purchase the full version at \$39...or get both for the price of \$49). IM offers you e-cards, letter backgrounds, sounds and animation that you can add to personalize your e-mail. It also come with an mail notifier (of your choice) which will tell you when you have new mail. You can even make your own handwritten signature to add to your mail.

The thing I like about Incredimail (IM) is that I have such a large variety of letter backgrounds to choose from that I can add to personalize my e-mails. Besides the basic ones that come standard in the program, there are many more backgrounds, e-cards, animation and sounds that can be added (all free of charge) without having to make your own...if you're not talented enough like me...by going to Incredimails's multimedia web gallery, or to one of the many IM websites where you can find a variety of all of these plus help with problems you may encounter. These sites also list other sites where you can learn how to make your own backgrounds using either Letter Creator or using a different program such as Paint Shop Pro.

One of the IM letter sites I went to (http://groups.yahoo.com/group/A_S-A-F-E_Place/) offers a link to tutorial classes at <http://enchanted1designs.com/abcs/about.html> that have at least 2 tutorial links every week for the following subjects:

psp (paint shop pro), eye candy (plug-in for psp), blade pro (plug-in for psp), sig tags, making letters for LC/ Incredimail & 20/20. Classes last for 8 weeks & have a top limit of 30 "students" per class. The owners of this tutorial site, Becky & Candy, said, "We have had great success with the classes so far & have high hopes of it's continuous success!" Hey... If I'm in the class, they can't be bad...right??? So check it out!!

Ok, some people (I won't mention any names Wayne) don't like me to use this program because it takes a little longer to download than a standard e-mail, but at least I don't use sound which DOES take a long time to due to the midi or wav file attachment.... All you have to remember is that the more you add to an e-mail, the longer it will take to download. If someone does not like receiving these "stationary" e-mails, ask them to let you know and you can then select a "no background" and they will receive a standard e-mail with a white background. Most people do not mind that it takes a little longer since there are so many neat backgrounds or sidebars (including your own pictures) that can be seen and that they can "snag" or add to their own collection just by viewing yours.

One thing about e-mail programs, you ****do**** have a few choices... you do not have to stay with the default selection that is given you. Use your imagination... use it in color... use it with pictures...it's all up to you!!

This article is brought to you by the Editorial Committee of the Association of Personal Computer User Groups (APCUG), an International organization to which this user group belongs.

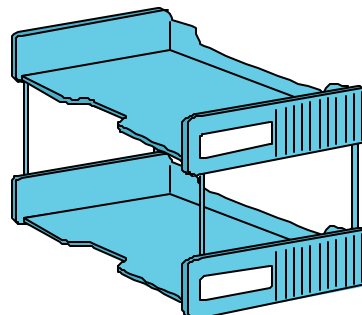

The Plain Truth about Casual Software Piracy

Piracy and how it affects a small software firm

by Matt Slot, Ambrosia Software

It's a rare day when a shareware programmer gets firm statistics on the extent of software piracy, but just recently, I got that chance.

You see, the company I work for—Ambrosia Software—writes and publishes shareware—software that encourages users to make lots of copies and share them with friends. It works like this: we write a game or utility and make it available for download and on low-cost CD, so you can install it and try it out for a while—kick the tires and drive it around the block a few times, so to speak. If you like it, you can buy the product; if not, just delete it or pass the CD on to someone else. <http://www.ambrosiasw.com>

We make money, and stay in business, by selling software that competes with commercial products for quality and entertainment value, while remaining priced so that it doesn't stretch the pizza-and-beer budget of the average college student. There's no bait-and-switch going on: you get a fair chance to try out the product and decide if your \$25 could be better spent elsewhere. We think our software is competitive—\$25 will cover a burger run and movie ticket for about three hours entertainment, but a good game can entertain you for days or weeks—and we won't make you watch Jar Jar Binks.

A few years back, Ambrosia's software was distributed on the honor system. You could download the software and use it forever, scot-free except for the friendly reminders that you had the software for 1,500 days and still hadn't beaten level 6. This was obviously a big leap of faith on our part, but it built up an almost cult following among Mac users. What we lost in sales, we made up in good will. As a business model, the honor system wasn't ideal, but it certainly was idealistic, and it helped put Ambrosia's founder, Andrew Welch, through college and kept Ambrosia's employees supplied with pizza and beer. (I think there's a law of conservation at work there.)

This was all fine and good—except that eventually Andrew graduated and everyone else got sick of pizza and beer. Ambrosia grew from an interesting sideline into a full time place of employment. The company became an entity with its own purpose, its own office space, and its own gravitational pull. It also developed an insatiable appetite for cash, because as any MBA will tell you, the lifeblood

of business is green.

This period of growth and rampant consumption was constrained only by the limited diet afforded by the generosity and honesty of others. Basically, money was tight. One way we encouraged users to pay for the game *Escape Velocity* was to introduce the character of Captain Hector, who would remind (and eventually harass) players who were still unregistered after an extended period of play. When we compared sales of *Escape Velocity* to those our previous products, it became apparent that either pizza and beer had become a lot more expensive or that some people needed an extra nudge—such as from Captain Hector—to do the right thing and pay up.

Locking The Front Door

Shortly after I joined the Ambrosia team, Andrew forwarded me an article that illustrated the benefits of crippling software. In short, the author of a shareware program found that people were five times more likely to register and unlock a crippled version of his software than they were to register software that came fully functional from the outset. It was the final straw in our camel-breaking, decision-making process. We would still make shareware, but we would no longer stand there waiting for handouts on the street—we'd charge admission. <http://hackvan.com/pub/stig/articles/why-do-people-register-shareware.html>

Let me tell you, we heard about it. Many who had praised us for our idealism were now calling us sellouts. It didn't matter that little changed for our paying customers—they still got their codes quickly, and had unlimited access to the game—it was the principle of the thing. Okay, it was a little inconvenient if you'd lost your code or wanted to install it on your new Power Mac 7500, but we could resolve that quickly in response to a phone call or an email.

I mean, we like being cool and fair, but even a cult following can get tiresome (cultists don't shower, they track in mud, and they leave you to pick up the check). Besides, the mantra kept repeating in our heads: five times as many registrations, five times, five times. I don't think it ever

was quite that good for us, but we definitely saw an increase in sales that helped Ambrosia weather some tough times. (No, we never actually ran out of pizza, but there were times when we had to mop up spilled beer with borrowed rolls of toilet paper.) It was a hard decision, but it was a business decision, and it turned out to be the right one.

Time passed. Our staff continued to grow and evolve, and my wife and I begat our son Luke. Nothing brings home how untenable your professional and financial situation is like having a family. When it was just my wife and I, we could fool ourselves into thinking that we were just coed roommates living on a college budget—but no more. Pizza and beer had given way to diapers and life insurance.

Diapers And Life Insurance

So I'm working for this shareware company, and I want to make sure that my job is secure. You have to understand that even a 10 percent variance in Ambrosia's registrations means that someone may need to start checking the employment classifieds. At the same time, it's becoming more evident that people aren't just not paying for our software—they're actually going out of their way to share license codes with others over the Internet. Some ingenious folks have even reverse-engineered our software and figured out how to generate their own license codes.

We don't live with our heads in the sand. We knew what was happening. The Internet was the great facilitator of homework assignments and world peace, but it had also become a way for people to get registration codes for any software they wanted. We felt action was required, but we remembered the trauma of our last change in policy when we required people to register the software instead of just asking nicely.

So over the course of numerous lunches (many of which didn't include pizza or beer, but did involve some

yummy sandwiches from Arby's), we discussed various ways for improving the whole registration system from our standpoint without making the process onerous for our loyal customers. Simplicity was the keyword. The final piece of the technical puzzle fell into place one weekend as I drove through Canada, when I recalled a bit of algebra that would make our license code algorithm quite secure without violating any treaties or munitions bans.

When I finally contacted Andrew, I said to him one word: *polynomials*.

The blank look on his face continued for a long time as I explained how we could factor the serial numbers, secure our products, and even distribute codes that would expire and stop working when exposed to prolonged sunlight. With his grudging consent, we sketched out and implemented the first pass at the "new Ambrosia registration system."

The fundamental change we made was to build the current date into the license code itself. That timestamp is then used at just one point in the process: it forces the user to activate the product within 30 days, or the code expires and won't activate anything. Now, and this is important, the timestamp has absolutely no effect on the operation of the software after the code has been entered. Once personalized for the user's computer, it remains fully functional forever (unless someone wipes the system clean).

Snapz Pro X

The first product to use the new registration system was the latest version of our flagship utility, Snapz Pro X, which started shipping in June of 2001. Over the course of the summer, the system silently and steadfastly worked as intended. Most people didn't care that the license codes were now 12 digits instead of 8, and registrations continued apace. It wasn't until September that we received any negative feedback. <http://www.snapzpro.com>

You see, in September Apple upgraded Mac OS X to version 10.1, and many people were paranoid enough to reformat and perform a clean install. That meant the data file containing the software registration was lost, forcing most people to reenter their license codes. It also meant that anyone whose serial number was generated before August needed to contact us by phone or email to get an updated code. Of course, these people had paid already,

(Continued on page 12)

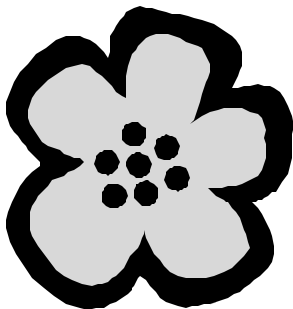

(Continued from page 11)

so we renewed their codes quickly and free of charge.

It's been our experience that people are often too busy or forgetful to store their license codes in a safe place, so it's inevitable that every major system release is followed by a barrage of requests for missing codes. To handle the tremendous load of people who had misplaced their codes (as well as those who saved them only to find they had expired), we created an email address—lostcodes@ambrosiasw.com—dedicated to generating new codes. When Joe User entered the expired code, he was prompted to send us an email (it required only a click), and someone would respond to the request as soon as possible. Yet we were constrained by the laws of time, space, and the New York State Department of Labor, so our staff was available to answer requests only during regular business hours.

After several customer complaints, we decided to remedy this problem by automating the process of renewing an expired code. When an expired code is entered for Snapz Pro X, the user is encouraged to request a new license code from our automated server—right then and there! Renewing the code takes only two extra clicks, maybe an extra 30 seconds overall, but it puts the power back in the hands of the user. He can decide when to update his system, install software, and renew his license code at his leisure. Even at midnight just before a four-day weekend.

So you are probably curious about the benefits of expiring codes—why would anyone want this hassle? Let's look at the three categories. For paying customers with

an Internet connection, the extra work is minimal: an email sent to Ambrosia that's answered within one business day. For those organized enough to save their original codes, there isn't even a wait: they get the code on the spot. The only inconvenience comes to those people trying to enter a pirated code.

Which brings us back to the question, "How many people are using pirated codes?" The plain fact is that most people are honest unless given a chance to be dishonest. If they stumble across a working license code for software, or do a quick Internet search, then they can quickly enter the code and cover their self-loathing with the adrenaline rush of blasting aliens and squishing fish. Only the most hard-core computer user will try to reverse-engineer the software and crack the copy protection—and I'll be honest, there isn't much we could do to stop them. Crackers enjoy the challenge itself—the tougher the better—so if they want it badly enough, they'll find a way.

Historically it's been difficult to measure software piracy, but our experience is that the vast majority of users lack the time or inclination to modify software to bypass license checks. Here's the rub: these users might actually buy the software if it weren't so easy to find pirated codes. Thus, expiring codes are a good way to defeat (or at least hamper) this kind of casual piracy—the serial numbers stored in databases and posted to the Internet are viable only for a short while before they must be renewed.

Ironically, it's these casual pirates who are helping me measure the impact of piracy on our sales.

You see, to renew a stolen code, Joe User must contact a computer in our office. There's nothing nefarious about it—he sends us the user name and expired code and gets back a new license code or a suitable error message. We don't encrypt the data, we don't grab any personal information, and we don't even open a connection without explicit permission. But when Joe User clicks that bright shiny Renew button, our server records the product, user name, and the Internet address he came from.

For the first two days after we posted the latest update to Snapz Pro X, our server was busy. Of the 194 different hosts that tried to renew a license code, 107 of them sent in pirated codes (click the URL below to view a screenshot of an actual server log file; the entries highlighted in red are attempts to authenticate pirated license codes). Incredibly, more than 50 percent of the people installing the update entered one or both of the pirated codes we've known about for months.

Some of these people even tried several different variants on the names when the server refused them access



Washington Area Computer User Group (WAC) Meetings

The May WAC Meetings will be held on Saturday, June 15 and July 20, 12:30-3:30 p.m. at the Fairfax County Government Center, 12000 Government Center Parkway, Fairfax, Virginia. You do not need to be a member to attend. For more information on WAC meetings and events, call the WAC AnswerLine

("maybe I misspelled it"), and one guy got so frustrated he pounded the Renew button over and over every four seconds ("WHY *click* IS *click* THIS *click* NOT *click* WORKING???"") until our server blacklisted him for flooding. http://www.tidbits.com/resources/620/pirate_log_red.gif

You don't have to remind us that the sample isn't statistically valid. Nevertheless we think it's a reasonable approximation of reality—if not a little conservative. It certainly reinforces our perception that casual piracy is both significant and widespread.

Hopes For The Future

Maybe I didn't look these people in the eye, but they know I'm watching them. They indicated a real interest in our software when they thought they could use it for free, and this gives me hope that some may yet decide that registering is easier and more satisfying than stealing our hard work. If not, then either they were forced to stop using the software or they'll likely encounter me again, somewhere down the road. Next time, I'll bring Captain Hector.

I also hope this article explains to our customers (and other computer users out there) the impact that piracy has on small software firms like ours. I hope they can appreciate our decisions regarding the registration system and agree that the extra 30 seconds and two clicks are a minor inconvenience. If everyone pays for the products they like and use, companies like Ambrosia can stay in business and continue making cool products for everyone to enjoy.

Finally, I hope that these changes give me a little more job security, so I can continue doing what I love with some of the coolest folks I've ever met. Because I plan on working here as long as I possibly can, making great software and saving enough money so my kids can eventually go to college, where they can enjoy their share of beer and pizza.

Reprinted with permission of the author. Matt Slot has worked for Ambrosia for nearly five years, but life isn't just fun and games for the Bitwise Operator. When he's not calculating polynomials and fighting off pirates, Matt enjoys reading a good book (Terry Pratchett), watching a little television (24), and playing with his two kids (Luke and Kaleigh).

You can reach Matt at pfrect@ambrosiasw.com or

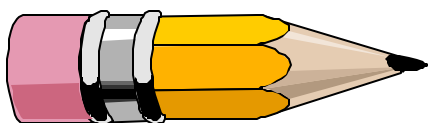

My Email Address Is Changing

by Don Singleton,
Tulsa Computer Society

Reprinted from the I/O Port Newsletter Tulsa Computer Society, January 2002, via APCUG

Many people in Tulsa have Cable Modems from Cox, and currently they have an email address which ends "@home.com", for example my true email address is "donsingleton@home.com". But that will not last for much longer (<http://investor.cnet.com/investor/news/newsitem/0-9900-1028-8055607-0.html?tag=ltnc>).

One alternative is to go to <http://mail.yahoo.com/> and signup for a Yahoo email address. They actually support three forms: Free Edition, Custom Edition, and Business Edition.

The free edition should be enough for most people. You will have an email address like donsingleton@yahoo.com. If you actually have your own domain name, the second form might make sense, but if so I would not recommend that you pay Yahoo \$35 a year to register your domain name, but rather I would recommend you go to some registrar like <http://inexpensivedomains.com> (the one I use) and register a domain name for \$15 a year. I am not absolutely certain, because I cannot be sure without actually doing it, but if one already has their domain name registered (through InexpensiveDomains), then it appears Yahoo just charges \$10/year for Personal Email services (5 email addresses), and as long as you authorize Yahoo to send you a few spam messages you can have them automatically forward email messages to your ISP provided e-mail address or you can have them provide you with POP3/SMTP access so that you can have your email program automatically get and send email through Yahoo Mail (<http://help.yahoo.com/help/us/mail/pop/index.html>).

This is not your only alternative. If you use InexpensiveDomains to register your domain name, then for \$14.95 per year they will provide Domain name and e-mail forwarding (<http://inexpensivedomains.com/webhost/forwarding.htm>). This means that you can attach your domain name to any website, even some of the free ones which don't support personal domain names, AND you can have your email forwarded to any email address you want.

(Continued on page 15)

(Continued from page 1)

Along with the above-mentioned upgrade frenzy of tax and anti-virus software comes rebate mania. Once again, boys and girls, Uncle Paulie reminds you to do as he says, and not emulate his procrastinating ways!

*Always remember,
and never forget,
send in them rebates,
before going to bed!*

I bought the TurboTax and Norton AV package deals on January 27, and allowed myself to be lulled by the cash register rebate coupons for NAV rebates. Symantec is liberal, and allows rebates for packages bought between 11-15-01 and 4-20-02, if postmarked by 5/20/02, for a \$30 rebate. Then there's a coupon in the box for previous owners for another \$20 rebate for previous owners, with even more liberal terms. If I succeed in getting both rebates, the software will be free.

Intuit, on the other hand, has a much tighter rebate program, and I didn't look at the details until I finished my TurboTax adventure on April 1st. The Intuit rebates have to be applied for within 30 days of purchase — *gotcha!* I've seen some rebates valid for only a week, so it's truly important to go through all the paperwork and apply for the rebates the day you buy the software.

Uncle Paulie's Lament

*Do it Now!
You lazy lout.
Spend not the day,
Plotzed on the couch!
Apply for rebates,
Fast and quick.
Funds for next year's
Taxman's nick.*

True confessions: I sent in the Intuit rebate forms anyway. Maybe in the tax-time crush, the rebate processors will overlook the "30 days from date of purchase" deadline? I figured it's worth a stamp and envelope to try. Consider it a protest on chintzy, restrictive rebate terms!

The whole tax preparation and filing process, using TurboTax, seems to get easier every year, since the program imports all the basic information from your last return into your new one. Electronic filing was better this year, too. Overnight acceptance of the return by the Federal and state tax authorities — last year the state took almost

a week. Virginia's come a long way — this year, we got our state refund back in about a week, with the Fed's taking about three weeks — not bad for filing on April 1st. I understand that folks doing VA taxes the old fashioned way, with pencil and calculator, who filed by phone got great service too, with virtually immediate refunds. Perhaps mechanization is really here. It sure would be nice if the tax authorities provided a tax credit for filing electronically, given the money they save in tax administration costs.

Does your PDA do this? Our debates and deliberations were being disturbed at a recent Pizza SIG by a huge "ghetto blaster" sited atop the Pepsi machine at our restaurant of choice. This boom box was cranked up to ear shattering levels, so the dishwasher could hear the latest Britney Spears masterwork. Roger Fujii dialed up the remote control application on his Sony Clié digital assistant, after I did a surveillance run to determine the manufacturer of the alleged sound equipment. The blaster's volume declined noticeably as Roger passed by on journey to wash his hands. Another victory for truth, justice, and technotoys!

The power of the Google internet search engine never ceases to amaze me, as it often finds just what I'm looking for in the first couple of returned items. At this week's meeting, Blair Jones mentioned that she'd used a service that converted a number of home movies from film to video tape some years ago in the interest of preserving family history, and wanted to make a similar conversion from VHS to DVD. I cranked in "VHS to DVD conversion service" in Google's search box, and out came lots of choices. Nick Wenri pointed out the "search in results" option at the bottom of the output page, which I'd never noticed before. Popping in "DC" brought up a narrowing range of choices for companies offering the conversion in DC or nearby areas — lots of companies apparently claim to be "near DC" in their web offerings.

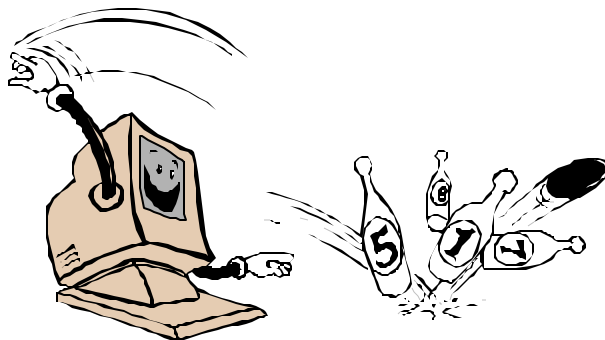

(Continued from page 13)

Either of these could be the way I have don@donsingleton.com as my email address. Actually I use a third alternative. VirtualAve/Hypermart (<http://www.hypermart.net/t/registration/packageinfo>) offer a series of webhosting packages, including one for free, as long as you are willing to have a banner ad on your web page. I don't know how much longer they will offer this, because this page (<http://www.hypermart.net/t/registration/packages>) does not show the free hosting alternative, except as a link at the bottom. But if you can sign up for a free website, you can point your domain name to it, and make use of their free email forwarding to send email to your ISP provided email address.

Actually there is one other alternative I can recommend. Webstrike Solutions (<http://webstrikesolutions.com/>) provides webhosting which just costs \$30 for the first year (they say it is free for the first year, but there is a \$30 setup cost), and then \$84 a year thereafter, and you can attach your own domain name to your account, and they have a free email forwarding service which can forward email from the domain name to your ISP provided email account. I use Webstrike for my Bush Supporter (<http://bushsupporter.org>) website, and Paula Sanders has three websites hosted by Webstrike.

Regardless of which of these alternatives you use, you will have an account which people can send email to, and it will be forwarded to the account your ISP provides, and then if your ISP changes your email address, or if you change ISPs, then all you have to do is go online and access your Yahoo/InexpensiveDomains/VirtualAve/Hypermart/Webstrike Solutions account and change the address it forwards your email to. The people you email will never know your real email account changed.

This article is brought to you by the Editorial Committee of the Association of Personal Computer User Groups (APCUG), an International organization to which this user group belongs.

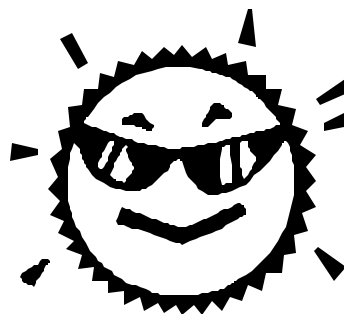

NCTCUG Information

NCTCUG, Post Office Box 949, Arlington VA 22216

Club Information call: 301-577-7899 Web Site: www.nctcug.org

Officers and Directors

All officer terms expire 2002

President	Jim Rhodes	703-931-7854
1st VP	Ron Schmidt	301-577-7899
2nd VP	Roger Fujii	703-280-1243
Treasurer	Paul Howard	703-860-9246
Secretary	Roger Arnold	301-946-7770

Director: term expires

Fred Boots	2002	703-370-4648
Blair Jones	2002	202-362-7344
John Keys	2002	703-451-0896
Nick Wenri	2002	703-759-3938
Fred Cook	2003	703-921-1749
JJ Davies	2003	703-379-9222
Sy Fishbein	2003	703-536-5894
Dean Mires	2003	301-931-2400

Article Submissions

Articles, helpful hints, and other items of interest to readers of the NCTCUG Journal are always welcome and will be published as soon as possible after submission. Priority is given to members' contributions. Items may be submitted via modem to the BBS or on diskette. Submissions to the BBS should be uploaded to the Newsletter Conference and a message left for the Editor. Files should be straight ASCII, unformatted, with C/R only at end of paragraphs; no indents for paragraphs should be used. Preferred format for diskettes is MS-DOS 3 1/2 720K or 1.44Mb. Diskettes in other formats may be submitted but there will be a considerable delay in processing. If absolutely necessary, items may be submitted in hardcopy only but these will also meet with delay.

Membership Policy

The National Capital Tandy Computer Users Group, Inc. is a non-profit [501-c(3)] organization founded in 1977 to educate users of all Tandy computers and MS-DOS compatible computers. Membership dues are \$25.00 (U.S. Funds) per year, with a \$5 surcharge for international mail. Membership in NCTCUG includes membership in all SIGs, access to the BBS and software libraries, and subscription to the Journal published 10 times per year. Applications may be obtained at any club meeting, by downloading from the BBS, by calling one of the officers or board members, or by writing to the club. A sample newsletter, membership application and related information may be obtained by enclosing \$1 and mailing your request to Jim Rhodes, 201 S. Kensington Street, Arlington VA 22204.

Advertisement Policy

Members' advertisements: Ads are accepted from members for non-commercial purposes at no charge. Copy should be sent to the Editor in the same format as article submissions. Commercial Advertisements: Ads are accepted from commercial advertisers at the rate of \$60 per full page, per appearance, with discounts for multiple insertions. Smaller ads are priced accordingly. Payment for ads must be made in advance of appearance. Advertisers must supply a permanent address and telephone number to the editor.

Reprint Policy

Permission to reprint articles from the NCTCUG Journal is given to school, personal computer club, and nonprofit organization publications, provided that: (a) NCTCUG Inc. receives a copy of the publication; (b) credit is given to the NCTCUG Journal as the source; (c) the original author is given full credit; and (d) the article author has not expressly copyrighted the article. Recognition is one means of compensating our valued contributors

Newsletter Staff

Editor

Blair Jones 202-362-7344

bjones44@bellatlantic.net

Exchange Newsletter and
Articles Editor

Ron Schmidt 301-577-7899

COMPUCENTER BBS

Is no longer in operation. It has been replaced by the 'compucenter' mailing list at <http://groups.yahoo.com/>

If you are moving

Please send your change of address to the club PO box as soon as possible to avoid missing issues.

Got A Question?

By Blair Jones

Still can't find an answer? Try getting a pro in on the job.

Google also has a service called "Go ogle Answers".

"Google Answers is a way to get that help from Researchers with expertise in online searching. When you post a question to Google Answers, you specify how much you're willing to pay for an answer and how quickly you need that information. A Researcher will search for the answer and send you the information you're seeking, as well as useful links to web pages on the topic. If you're satisfied with that answer, you pay the amount you specified.

Your question will also be published on the Google Answers website so registered users can add their insights and share in the benefit of the research."

There's a 50 cent listing fee.

See <https://answers.google.com/answers/main> for more information, and a look at some current questions (some have answers).

<http://www.google.com/about.html> has a number of Google links that make interesting exploring.

??????

NCTCUG, Inc.
P.O. Box 949
Arlington VA 22216



First Class

June/July 2002

1st Wed. (6/5, 7/3) **7 p.m.** Virginia General Meeting

4th Wed (6/26, 7/24) **7 p.m.** Internet SIG

3rd Monday (7/15; no meeting in June) **7 p.m.**
Board of Directors

All meetings are at **Carlin Hall**, 5711 S. 4th St., Arlington VA: East off of Carlin Springs Rd, just south of Arlington Blvd/Route 50.



Visit The Club Website

www.nctcug.org