



# The NCTCUG Journal

www.nctcug.org

February 2004

Volume 27 Issue 1

## Keeping Up

By Paul Howard, NCTCUG

Well, girls and boys, another New Year dawns. How many of your resolutions have you broken, and we're not a month into 2004? I'm totally guilt-ridden, having also made a raft of pledges to exercise, eat right, clean up the basement, etc., etc., on my retirement in November. (Pass the pizza, Chuck, I need my strength for all those chores <grin>!) And in just a few weeks we have to pass that other great integrity challenge — now where was that paperwork for claiming the backyard squirrels as dependents on form 1040?

My primary computer must have been re-cursed by the wicked witch shortly after Halloween. After putting in my second replacement hard drive in October, and starting the laborious process of reloading software, it's off in Neverland again. Booting takes an hour, and the display's in 16 colors, with all kinds of nastygrams about "programs can't run" with that display setting. I've been lazy about tearing into the

computer and finding a cure. My backup machine's been putting along and allowing me to keep my web chores up to date, although my email correspondence is suffering badly, with my master email directory on the sick machine.



The advent of the recent "Code Orange" security update seemed to call for additional preparation around the old homestead. Fairfax County was testy about parking an Abrams tank at the curb in front of the house, so I decided to invest in comm equipment instead. As many of us found out a few months ago when Isabel blew through Virginia, we are mightily dependent on the good old electric

*(Continued on page 15)*

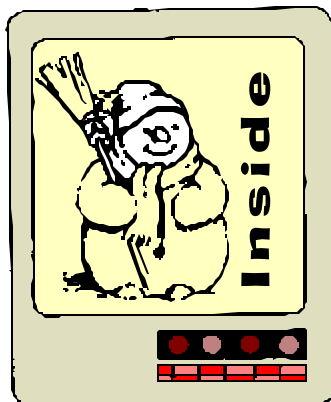

---

So, You Want To Build Your Own Computer, Turkey! .....	page 2
Digital Cameras For The Holiday Season .....	page 4
Accessories For That New Digital Camera.....	page 5
Computers From The Very Beginning For New Users .....	page 7
No More Video Tape .....	page 9
A Must-Have Program For Sharing Digital Images .....	page 10
Inhuman Computers .....	page 14
Selections From The Deals Guy .....	page 12

---

## So, You Want To Build Your Own Computer, Turkey! Or...A Billion Reasons Why Not By Mark Gladstone, NCTCUG

*Executive summary: DON'T — unless you have special needs.*

To begin with: “Dell/Gateway *et al*” have both hardware and software purchasing power with which you can't compete, even with internet purchases. The reason is twofold: bulk purchases and a concept called OEM. “OEM” is an abbreviation for Original Equipment Manufacturer. Everything else being equal, you will NOT SAVE MONEY! by doing it yourself. If what is offered by “Dell/Gateway *et al*” comes close to fulfilling your needs, you should carefully look to getting your new computer from them. One of the caveats is that the add-ons jack the price up far beyond what is reasonable; it is a marketing ploy. Another is that you must realize that they are pinching pennies to make money with a low margin product. For example, one of the advertised Dell low-end computers comes equipped with a “40 gig value hard drive”. The upgrade to a moderately decent 80 gig 7200 rpm ultra hard drive will be close to \$100. But nevertheless, if you can find a package that suits you, do it. Unless you have special needs.

I helped my daughter select her middle-priced Dell computer. It had, frankly, most things that most people will want. And of course it comes bundled with a bunch of (OEM) software, because they and others are an Original Equipment Manufacturer. What that means is that “Dell/Gateway *et al*” is responsible for software support, rather than the developer/distributor of a retail box of the software. This is a plus, because they are geared to deal with those folk who haven't the foggiest notion what computers are about; if you've been on hold to Intel, U.S. Robotics, Micro\$oft or any other tech support people and then get connected to a nerd who can barely speak English, you'll know what I mean.

The negative side was that I needed to install a cable/modem board from my daughter's old computer into the new one. When I opened up the case, I discovered that there was only one open slot left. If you

have special needs with special boards, be careful that you know that the model you are getting has enough additional slots for expansion.

But most of them have very few additional slots. And so if you require several additional cards to fill your needs, then you must build your own — or have someone build it for you.

I had some special requirements. I have an extensive collection of open reel tapes. Some are unique off-the-air broadcasts of performances not otherwise obtainable. And so I wanted to transfer those tapes to CD with maximum quality while the tape deck and external dolby unit are still serviceable and the tapes haven't printed through. Investigation through forums and otherwise had shown that the ordinary consumer quality sound card such as Soundblaster or Turtle Beach wouldn't do the job properly. I required a professional quality card — very expensive.

My other need was to get a motherboard and processor that would support the new 800mHz bus and hyper-thread technology, as well as having compatibility with my sound card. None of the “Dell/Gateway *et al*” folks had such support. In fact, those products weren't yet available at your local CompUSA. A further need was to satisfy my own stupid paranoia; I needed to know exactly what was inside the case. Dum-Dum.

Now that I had determined my needs, the next step was to shop. I discovered that internet pricing was far below retail. So I ordered my Intel motherboard and processor over the internet from the cheapest supplier. The price was far below even the older systems available through normal retail sources. Behold what arrived! I received the motherboard and a whole bunch of individual components packed inside a FedEx envelope — no documentation. Fortunately, the vendor's invoice contained a telephone number, so I called for tech support. I was told that what I received was an “OEM package”, and that only the retail package contained the printed docu-

mentation. However, I could print the docs from the installation CD. Also fortunately, my old and working computer has a CD drive. So — many, many pages later, I was able to get printed documentation.

One of my other needs was to have a high quality sound system, so I could best edit the music before burning the CD. Again surfing the internet, I ordered a high-end Altec Lansing THX five speaker and bass system priced far below retail. What arrived had Altec Lansing in small letters on the bass unit and “Dell” all over the place. Included were glossy instructions for hooking up the speakers to my “Dell computer”. OEM, baby.

I also shopped the internet for software. The prices for XP Pro and WordPerfect Office 2002, among others, were far cheaper than retail. Guess what arrived? You got it — OEM, baby. Interestingly enough, the cover to the WordPerfect CD states: “IMPORTANT: Not for sale or resale unless bundled with original equipment. Please contact ... if you have purchased this product without original equipment”. Duh!

And so on, and so on. Realistically, however, had I purchased from retail sources, I would have needed to take out a second mortgage to pay for it.

Now we come to the interesting part — installing the hardware and configuring the operating system. I will spare you, dear reader, the totally unprintable and gross language, the stomach cramps, and large ingestion of beverage-grade ethanol.

The major connectivity problem was between the myriad connections from the Antec tower case (six external bays, four internal bays, and a 400 watt power supply) to the motherboard. The major problem was that the Antec folks’ documentation and the Intel gurus docs didn’t quite match. In desperation, I got my 12-year-old nerd neighbor, who has fingers that are smaller than mine, to mess around until the correct combination of connections were accomplished. The rest of the connections between hard drive, floppy, DVD ROM reader, and DVD burner, were done with few minor problems. I connected it up, plugged everything in, and powered up. Everything worked — or so I thought.

The next task was to install Windows XP Pro OEM edition. At this point, you probably understand that most software developers won’t give you the time of day to support OEM software, especially Micro\$oft. Simply put, the installation crapped out midway through the process, and help I could not get. I tried several times, re-formatted the hard drive, and even tried with my neighbors’ XP Home. There was nothing I could do to get the O/S to install. So I bit the bullet and took the computer to a computer store that was highly recommended by one of the local magazines for computer repair.

They, themselves, admitted to me later, that these professional gurus had to scratch their heads several times. What they suspected was a “memory problem”. Why they suspected that I will never know, as I checked all the settings that I knew how to check during installation. They finally contacted the memory folks. I had installed 1 gig of the latest dual-channel high speed memory that supports the new 800MHz architecture. It seems that the ROM BIOS in the motherboard was configured for the old-fashioned single-channel slower bus speed memory by default. Remember that this wonderful new Intel product supported all the new processor, memory, and bus features. But NOT BY DEFAULT! The Intel documentation didn’t touch this issue. The gurus were instructed how to configure the BIOS, which they did, and I picked up a completely installed, working computer from them, at a cost of a few bills. Well worth it.

So...you want to build your own computer, turkey?

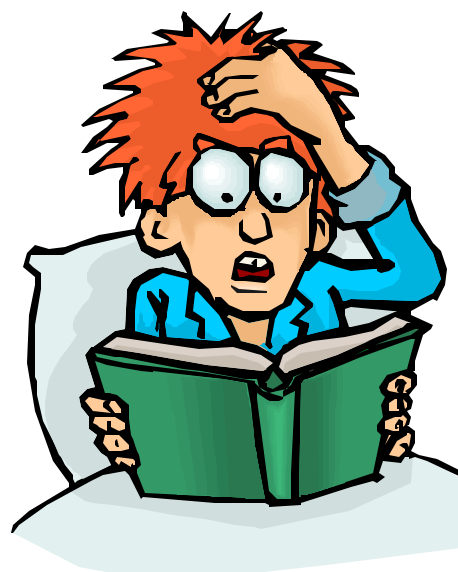

## Digital Cameras For The Holiday Season

By Ira Wilsker

Whether advertising hype or legitimate analysis, many of the published pundits are predicting that this winter will be the prime season for digital camera sales. In compliance with traditional technological history, digital cameras have improved in quality and features while plunging in price. I got a “deal” on my first digital camera three years ago, with 640x480 resolution which is 0.3 (that’s three-tenths) of a megapixel resolution, 10x optical zoom, slow serial connectivity, and 2 megs of memory for \$270, about one-half retail. For the record, that camera still works fine. Today our local retailers are offering technologically superior digital cameras with 10 times the resolution and 16 times the built-in memory, with fast USB connectivity, for about the same price. In many markets, digital cameras far outsell comparable 35mm cameras. Digital cameras require no film (only memory), require no processing (no trips to the photo counter with the concurrent cost of processing), and provide the instant gratification popularized by the obsolescent Polaroids of yesteryear.

Two of my daughters expressed an interest in a digital camera for the holidays so I have been shopping around. There is a myriad of techno-babble terms being bantered about in describing digital cameras that may require some explanation here so all can understand.

The primary feature being touted by digital camera makers is “megapixels”, or millions of tiny dots of resolution. A “pixel” is the common vernacular for “picture element”, which is each tiny dot of information that you see on your computer screen. To put megapixels in perspective, a computer monitor with the common 800x600 resolution means 800 pixels wide by 600 pixels high, or 480,000 pixels. Likewise a 1024x768 resolution, common on today’s 17 inch monitors, is 786,432 pixels. If the primary intent is to email digital photos, or post them to the web, then very high resolutions are unnecessary. Someone recently sent me a huge image file as an email attachment. The picture was of a new grandchild, and taken with a 2.1 megapixel camera, at

maximum resolution. The sender did not practice good “netiquette” and reduce the size of the image to reasonable dimensions (such as 320x240 or 640x480), so his large image was three times the size of the screen on my 17 inch monitor. The only way to view the unedited image was to scroll left and right, and up and down. In most cases there is little need to take photos at the maximum resolution; almost all cameras allow for smaller, lower resolution photos.

If the user wants to print the photos with a photo grade printer on high quality inkjet or laser photo paper, 2.1 megapixels, can produce an excellent quality 5x7 inch print, and a reasonable 8x10 inch print. Many of the moderately priced digital cameras are now being offered with 5 or more megapixels. With an appropriate printer and paper, 5 megapixels can produce an excellent quality 8x10 print, and a decent 11x17. The holy grail of digital cameras, 12+ megapixels, the resolution of good quality slide film, was passed about two years ago by the high-end professional models. Many professional photographers, who dismissed digital photography as a low quality fad a few years ago, are now embracing the new technology.

The ability to zoom the image in and out is a popular feature in most cameras. The two methods of zoom available on digital cameras are optical and digital zoom. In terms of sharpness, optical zoom is superior to digital, as the image itself is manipulated, rather than the pixels making up the image. The less expensive cameras typically only offer digital zoom (adequate for common snapshots), but the better cameras offer either optical zoom or a combination of the two.

The memory available to the camera determines how many images it can hold before the data must be downloaded to a computer or other device. Most digital cameras have some built-in memory, and allow for the addition of supplemental memory in a variety of formats. Some cameras minimize the need for digital memory by writing the image di-

rectly to a floppy disk or mini-CD. Since the integral memory in a digital camera can typically hold only a small number of images, it is important to determine the price and availability of additional memory in the proper format. Memory comes in different capacities and formats from tiny cards, to rectangular “memory sticks”. All camera memory is not the same, and differs in speed (faster is better, but often at a price), and power consumption (less power consumption is better by prolonging battery life). According to Lexar, one of the major manufacturers of digital camera media, the number of photos that can be held in memory varies by the resolution of the photo and the capacity of the media. If the inexpensive 32meg memory card is used, at maximum resolution, a 2 megapixel camera will store about 35 images, while only storing 12 images from a 5 megapixel camera. Media of 256megs (often around \$50) can hold much more; 284 images at 2 megapixels, and 102 images at 5 megapixels. A chart showing the capacity of different media is available at [www.lexarmedia.com/digifilm/index\\_cf.html](http://www.lexarmedia.com/digifilm/index_cf.html). It should also be noted that the memory, also referred to as “digital film”, can be reused indefinitely.

Almost all new digital cameras come with some form of fast USB connectivity to download images to the computer. Accessories such as docking stations, and external card readers are a convenience, but not a necessity.

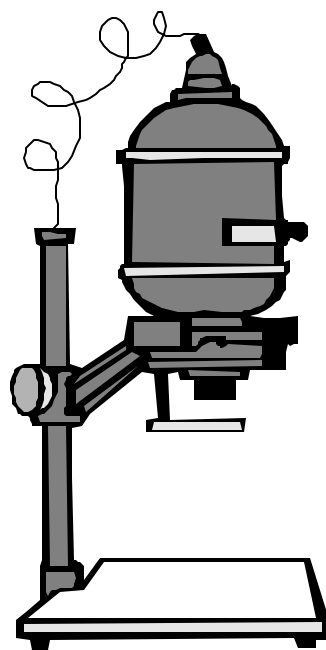

As an added convenience, most local photo finishers now print photo-grade images directly from the camera memory, at prices lower than printing them yourself. Now we can have the best of both worlds.

## Accessories For That New Digital Camera

By Ira Wilsker

[In the previous article] I wrote about the features to look for in a new digital camera. That column was most timely as many in the national media are predicting that digital camera sales will soar this holiday season. It is also common that many of us “accessorize” our gifts to others to enhance the enjoyment of the recipient. Appropriate accessories would include cases, memory, photo editing software, photo printers and paper, rechargeable batteries, and other useful items.

Cases for digital cameras are usually available from the camera makers as well as a broad assortment of third parties. The primary function of a case is to provide protection for the sensitive instrument. Other functions include a means of conveniently carrying the camera, and a place to store accessories. In shopping for a case, look for proper fit and good protection from harm, as this is the function of a case. This protection may be in the form of padding, water resistance, and a variety of other factors. Do not practice the fine art of “buying cheap” and trusting a several-hundred dollar camera to a five dollar case, unless that case can provide adequate protection and convenience, which will not be likely.

Additional camera memory may be one of the most valuable adjuncts to a new (or already owned) camera. Almost all new cameras come with integral memory which can only store a very limited number of images before it must be downloaded to a computer, or the images in memory must be deleted to make room for more. While some cameras, such as several of the Sony models, use a floppy disk or mini-CD-R disc to store images directly to a universal media, almost all other digital cameras use some type of nonvolatile memory card or stick to store images. These cards or sticks are inserted directly into the camera, and provide additional storage for images. In shopping for camera memory be absolutely sure that the proper type is selected for the camera, as there is often little interchangeability

*(Continued on page 6)*

(Continued from page 5)

between the types. Common types of memory are “CF” compact flash, smart memory, multimedia cards (MMC), “SD” secure digital cards (sometimes interchangeable with MMC), tiny “xD” cards, memory sticks, and several other formats. Normally, “more is better” applies to memory capacity, but price must also be balanced with capacity. If photos are taken at full resolution (not normally a best practice), a 2 megapixel camera uses about 900k for a single JPEG format image, so a 32meg memory card will hold about 35 images, while a 128meg card will hold about 142 images. Other resolutions and amounts of memory will be somewhat proportional. A 4 megapixel camera uses about 2 megs of memory for each image at maximum resolution. Another factor which varies among different models of memory is the speed (faster is better) and power consumption (less is better). Along with a new memory card, an external reader, typically with a USB connector, is a great convenience which enables photos to be transferred without the camera.

Almost all digital cameras come with a “lite” or limited functionality photo editing software. The included software may be adequate for normal snapshots, but often we want to do more to enhance or improve our photos. Near the top of the price range of popular photo editing software is the Adobe PhotoShop at around \$600, and its lesser brothers from Adobe including PhotoShop Elements (about \$90). One of the other powerful photo editing and enhancement utilities is JASC’s PaintShop Pro 8, available locally for around \$60. I especially like PaintShop’s “One Step Photo Fix” that can auto-

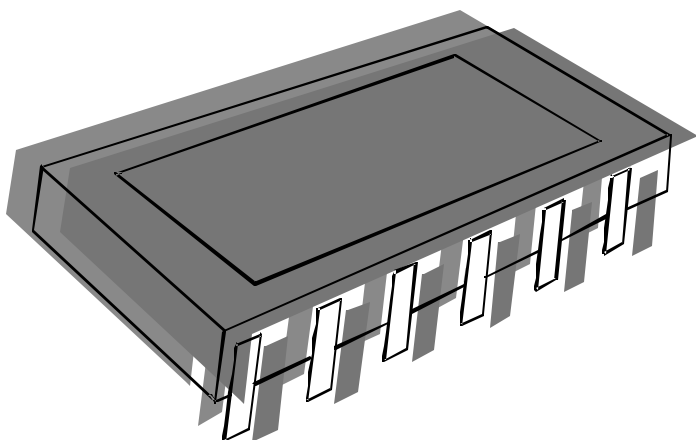

matically perfect almost any reasonable digital image. For the bargain hunters who want a powerful editing and enhancement utility, without paying big bucks is the very popular Irfan Viewer, which is available for free download from [www.irfanview.com](http://www.irfanview.com). Personally, I use both Irfan and Paint Shop Pro about equally. Other editing software is available from other publishers.

Most color printers on the market today can print plausible color images using stock inks and decent quality paper. Some printers offer enhanced photo printing capability for a moderate price, while there are also dedicated photo printers on the market. Good photo grade paper is a necessity to produce quality prints. Some printers on the market print directly to Polaroid film, giving real photos from a digital camera. Many users prefer both the quality and economy of having their local photo finisher print digital prints, a service which most now provide, often at prices less than “do it yourself”.

My digital camera eats batteries. Using AA alkaline batteries would be a major expense, if it were not for the now common NiMh or Lithium rechargeable batteries. Many cameras utilize the common AA size, and as an added advantage, the better NiMh rechargeable batteries typically offer many times the photos of disposable alkalines, at a far lower cost per picture. Spare batteries, especially if fully charged, can be a godsend.

Other popular accessories for digital cameras may appeal more to the advanced user than the amateur. These include tripods, accessory lenses, external flash devices, and other items. Just be sure that the accessories are compatible with the user’s camera.

Ira Wilsker is the Advisor for Region 8, APCUG Representative & Bylaws Chair for the Golden Triangle PC Club, a columnist for The Examiner in Beaumont, Texas, and has two radio shows. He also graciously shares his articles with the APCUG editors. There is no restriction against any non-profit group using this article as long as it is kept in context with proper credit given the author. The Editorial Committee of the Association of Personal Computer User Groups (APCUG), an international organization of which this group is a member, brings this article to you.

# Computers From The Very Beginning For New Users

By Charlie Paschal, Editor/Publisher, Palmetto Personal Computer Club, Columbia, SC;  
Columnist, The (Columbia) State newspaper, SC

After watching my 76-year-old sister struggle with her first computer, I decided to start a beginner's series on de-mystifying a computer. We're going to start from the very beginning and if I move to fast or use terms you don't understand, please send me e-mail about it.

I hope this can make your computer more "user friendly" for you.

Even if you're not a beginner, you might know someone who is and point out this series to them. Over a period of several issues, I hope to decipher the language, destroy the myths and, perhaps, entice beginners to overcome their fears of computers and begin to use them more effectively.

First, and foremost, why would you buy a computer in the first place?

Most of us use them for little more than the ability to dial up the Internet, send a few e-mail messages and do some simple searches. Despite these small expectations, it's still a struggle for my sister to learn how to use the computer.

In watching her, here are some things I've noticed that she struggles with:

- ☞ Clicking and double clicking.
- ☞ The individual parts of a window, such as the scroll bars, thinking other information on a page or document is "hidden" from her or not on the page. (Remember when a small baby played hide and seek? Small children thought you actually "disappeared" until they got older. This is almost the same thing—if you don't know where to look for the remainder of the page.)
- ☞ The difference between two separate Web sites.

☞ Why certain searches don't turn up a Web site ("That's what so and so told me to search for," she says when the search turns up empty, rather than considering that she might have "bad" information.)

A computer doesn't think in the way humans do—it works in ones and zeros and that's the only way it processes data. It uses binary and hexadecimal numbers rather than our decimal system.

You might think that a computer can't reach high numbers using this system, but it can. By using just ones and zeros, a computer can count to incredibly high numbers and just loves to do so. A computer uses these numbers to "hand out" addresses to each part (such as a printer port) or program, so everything knows what street they're on when the operating system (or hardware) needs to reach them.

Ever had a program "perform an illegal operation" or crash on you? This usually happens because one program tries to use an address already occupied by another program or piece of hardware. It's just like a bill that's delivered to the wrong address.

The operating system is the part of the computer that handles the hard work behind the scenes: Handling communication between an application, such as Microsoft Word, and a printer. When a user clicks on "print" in a Word document, it's the operating system that intercepts and tells the printer (at its address) to print the document. A "device driver," usually from the printer manufacturer, does the chore but it's the operating system that handles the communication between Word and the printer. It uses memory addresses to keep order.

Microsoft Windows is an operating system. It comes in several versions. Although there are prior versions to Windows 95, most of us only know about Windows 98, Windows 2000 and XP. Windows NT is a heavy-duty operating system and is

*(Continued on page 8)*

(Continued from page 7)

mostly used as a “Web” server—a server (a beefier computer, with more high end parts than a desktop) that handles duties on the Internet.

Other operating systems include Macintosh (Apple), Unix and Linux, which is a version of Unix that runs on the same type of hardware that Windows uses. Unix runs on different hardware, as do Apple computers. Programs that run on Apple’s hardware won’t run on Windows computers and vice versa. Some special programs allow some programs that run on Windows to run on Linux.

The “hardware” part of a computer is the computer, monitor, keyboard, mouse, printer and other devices. The “software” consists of the programs and the operating system. Examples of software include Microsoft Windows, Microsoft Word, a virus checker or Outlook Express, an e-mail client.

Questions, comments: [comments@askcharlie.com](mailto:comments@askcharlie.com)

There is no restriction against any non-profit group using this article as long as it is kept in context with proper credit given the author. The Editorial Committee of the Association of Personal Computer User Groups (APCUG), an international organization of which this group is a member, brings this article to you.

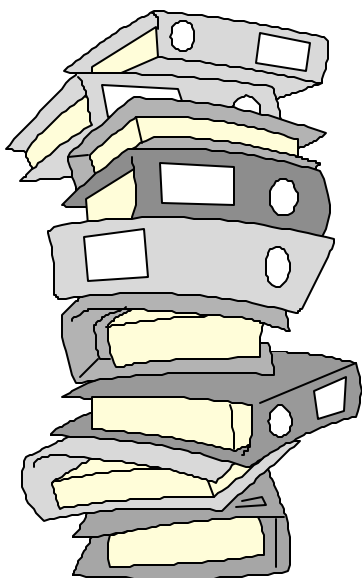

(Continued from page 9)

minute presentation. The presentation starts at 10 a.m. on the east coast of the United States. The videographer can pack up his equipment, get home, load the video into his computer, and encode it at VHS quality for transfer over the Internet by noon. By 12:30 p.m. the video is on a server ready to download by whoever knows where it is and has the password to allow them to download it. By 1:00 p.m. those in the know could have downloaded it and are on their way with their laptop, with the video on it, to an awaiting LCD projector in the meeting room of their group where the presentation will be shown. Of course 1:00 p.m. on the East Coast is only noon in Chicago, 11:00 a.m. in Denver, or 10:00 a.m. on the West Coast. It is still even early enough for an evening meeting in London, England. Associations of such groups may even set up their own video news services for the benefit of the members of their groups using this technology and possibly have a newsreel available of what has happened in the groups belonging to their association over the last week or month.

With video being stored in solid state memory modules or DVD in the camera, we will no longer have the problems of video tape. We can almost instantaneously access the portions of the video we want from the point where it is in the camera and enable quick long distance transfer of video via data networks like the Internet.

It is already starting to get to the consumer level, which may affect how we even hold common meetings and events. The effects of such technology may affect our lives in many ways in the not too distant future.

Timothy Everingham CEO of Timothy Everingham Consulting in Azusa, California. Vice Chair of the Los Angeles Chapter of ACM SIGGRAPH, the largest chapter of the Association for Computing Machinery’s (ACM) Special Interest Group on Computer Graphics and Interactive Techniques; member of the Management Information Systems Program Advisory Board of California State University, Fullerton; Vice President of the Windows Media Users Group of Los Angeles. As part-time press, he has had articles published throughout the United States, Canada and Australia. He is a member of several user groups in southern California. Further information can be found at <http://home.earthlink.net/~teveringham>.



## No More Video Tape Implications Of Video Cameras Becoming Tapeless

By Timothy Everingham, [teveringham@acm.org](mailto:teveringham@acm.org)

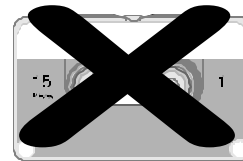

In video, we first changed over from editing with tape to digital editing with computers. Then we went to exporting the video—first to laser Disc and VCDs, followed by DVDs. As of this year we are in the transition of eliminating tape in video cameras. Sony introduced, at the Consumer Electronic Show in January [2003], consumer video cameras that record to Mini DVDs.

At the National Association of Broadcasters, they announced shoulder-mounted cameras for news crews that record to blue laser DVDs (four times the capacity of a standard DVD). And Panasonic shocked everyone with the announcement of a TV news camera that replaced tape with solid state memory modules. This camera will be available late this year, with a consumer handheld version ready in 2004 or 2005.

What does all this mean for those at the consumer and prosumer levels? For one thing it means no more tape mechanisms eating your video. It also means longer shelf life. With videotape, significant deterioration can happen within a year and by 10 years it is probably gone. With DVD-R or DVD+R media the life is expected to be 40-250 years. With DVD rewritable formats the life is expected to be 25-100 years. The more moving parts you have, the more you will probably have an equipment breakdown.

Sony has replaced a complex drive and tape feed mechanism with a more reliable optical disc recorder. Panasonic goes one step further by replacing all the moving parts of the recording mechanism with memory modules. As with DV cameras, these cameras will not have the transference problems of converting an analog signal to digital format, and their transfer rate will not be governed by the slowness of a tape deck or camera tape drive.

With Sony, the internal speed will be like that of a

DVD drive, and Panasonic like that of computer RAM. So the real limiting factor will be the speed connection method between the camera or player to the device being transferred to. The random access to any part of the video within a second allows you to quickly do a rough edit to get only the portions of what you have shot that are of interest. We are starting to see instant playback of weddings at the reception, and this new technology will probably increase this type of video use.

This will make it easy to transfer video over data networks. It used to be that you had to transfer video over satellite in real time if satellite facilities were available in your area. Later you physically had to travel to a place where you could digitize the video by hooking up a camera or tape deck to a computer and then send it over a land- or satellite-based digital network at speeds faster than real time. Now you can directly transfer the video from the camera using a portable satellite dish or even the Internet very much faster than real time. (This technique was used by embedded reporters in the recent Iraq war, but the new technology should make such transfers even faster).

The average consumer with a broadband Internet connection should be able to take advantage of this too. Your video is transferred at Firewire rates or faster, so transfers of a ½ hour video from your camera to your computer can be accomplished in three minutes or less. The big issue will be to convert the video from standard DV to MPEG-4 or Windows Media. If you are using a 2.4 GHz Pentium 4 or better it should take about the same amount of time as the length of your video, but for DVD quality it should take three times as long.

The implications for professional and consumer associations and user groups, computer related or not, could be phenomenal. Take a typical 45-

*(Continued on page 8)*

## A Must-Have Program For Sharing Digital Images

By Ron Hirsch Boca Raton Computer Society, Inc.

If you are involved with digital images and want to make slide shows to showcase those images, and/or give copies to friends and family via CD's, or several other means, I strongly recommend a program that you absolutely must consider using. The program is called "Digital Photo Slide Show." It's available at: [www.digitalphotoslideshow.com](http://www.digitalphotoslideshow.com).

Like all shareware, you can download the program, and try it out before you register it. It has an amazingly low registration fee of \$19.95, and this includes free lifetime upgrades. The author, Jim Voelker, has done a fantastic job of creating an easy to use, but very powerful piece of software. It can meet the needs of advanced users, but can also be used easily by beginners.

In this review, I'll cover many of the highlights of this program. For complete information on this program, visit the Web site above, and browse around. Then download the program and try it out yourself. If you have a broadband Internet connection, the download will take less than a minute. Dial-up users will of course experience a longer download time, but it is worth the effort.

Periodically I've reviewed shareware programs here in Boca Bits. I only review programs that I feel are 5-star ratings. This program is actually better than my top rating of 5 stars.

### What Does the Program Do?

This program does a variety of things, and does them all well. One key feature which should appeal to BRCS (and TBCS) members is the capability to generate a self-running slide show, with lots of customized features. This show can be viewed on your computer. And, via a few simple steps, you can produce a CD with the slide show on it, and give it to friends and family to view on their computer. There are several options/ways for giving your slide show to others. You can:



- ⊙ Generate a custom screen saver with changing photo images of your choice.
- ⊙ Generate a customized and continually changing wallpaper for your desktop.
- ⊙ Generate a Web slide show.
- ⊙ See "Other Features" for other capabilities.

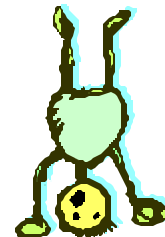

### How Does It Work?

The user assembles a group of photo images, and places them in a designated folder. It's best to have already edited/cropped/retouched these images so they are what you'd like to display.

Once you have this folder of images assembled, the bulk of your work is done. With the straightforward procedures that the program offers, it will take you only a few simple clicks to do the job that you want.

I've been using the program to generate slide shows from a large collection of scanned images of friends and family, starting back over 60 years ago. I go through the necessary steps, and then copy the final material onto a CD. That CD is set to be an auto running slide show.

So, when friends and family put that CD into their computer's CD player, a list of all the slide shows on the CD comes on screen, and they can choose the one they want to view. When that show is over, the listing comes up on screen again, and another show can be selected.

The beauty of this setup is that each slide show is just another sub-folder in the root directory of the CD. So, when one wants to add more slide shows, all that is needed is to add more subfolders to the master folder on your hard drive, and burn another CD with all the new material you've added.

*(Continued on page 11)*

*(Continued from page 10)*

Now, if you are saying to yourself “How do I do all this stuff with folders and subfolders,” maybe it’s time to resurrect my series of tutorials from last year’s Boca Bits. All that material is very necessary and important for computer users to have at their fingertips in their daily activities with any Windows program.

## Other Features

The program is loaded with all kinds of nice features that users can choose from. If you go the [www.digitalphotoslideshow.com](http://www.digitalphotoslideshow.com) Web site, you can get complete information on everything about Digital Photo Slide Show. Here’s a partial listing of features:

There are now 135 transitions to choose from. These transitions are used when the slide changes to the next slide. There are wipes, dissolves, and you name it. The user can choose a different transition for any slide, or let the program just cycle through the full library, or a lesser library by selecting those desired. And, the display time for each slide can be set, either individually, or via a single entry that will apply to all slides.

A caption text box can be added to any slide, and there are lots of nice formatting features available. Fonts, colors, size and position of the text box are all user-selectable. The text does not become part of the image itself or change the image in any way, but it is associated with the proper image automatically by the program.

When the images are displayed on the computer monitor, they automatically adjust their displayed size to the maximum that the monitor screen can display. This is a plus. The user doesn’t have to worry about playing with the image sizes—it’s all automatic.

At the top of the slide show display, there is a toolbar where viewers (should they desire) can pause the show, advance forward/backward manually, and a good selection of other options also.

Background music can be played, by simply adding the music file into the folder containing the image

files for that show. Add as many selections as you want, and they will be played in alphabetical order.

Slides are also played in alphabetical order. In my slide shows, I have the slides named by using the year and month, such as 6306, as the first characters of the filename. So, I don’t really have to do any renaming—I want them in chronological order. But, users can set the order for the images by simply adding a 3 or 4 numeric string to the beginning of the filename. If the file was named “picnic.jpg”, and you wanted this to be the first slide, change the name to “0001picnic.jpg.” Remember, you must use leading zeroes, or a group of slides that are numbered from 1 to 12, without leading zeroes, will play in this order 1, 10, 11, 12, 2, etc. But with a leading zero, they’ll play as 01, 02, 03, etc. This is the way Windows does sorting.

And, if you’re asking “How do I rename files?”, I’ll once again refer you to my tutorial articles from 2001 and 2002. This is more necessary information that you should know.



## Miscellany

Through the years I’ve produced many “slide shows”, all of which were personal in nature, and used thousands of images I’ve scanned from negatives, slides, and prints (actually, going back to before I was born, and that’s a long time ago).

I’ve used MS PowerPoint, Corel Presentations, and an “album” program called Diji Album. They all did a nice job, and they all had capabilities for distributing the “shows” to others. The one problem that they all had was that they had to have each page composed individually, as each page had to have the image sized, positioned, etc. The beauty of Digital Photo Slide Show is that I don’t have to do this anymore. All I have to do is put my images into a folder, and the program will position and size them automatically for me. And, since I’m now in the process of generating a whole new batch of shows, my workflow will be far more efficient.

I will of course have to manually add any captions that I want to use, but I’ve now decided that the only caption on most pages will be the date. That simplifies the caption box size and position—it’ll be the same on each page.

*(Continued on page 13)*

## Selections From The DealsGuy

**Bob Click, Greater Orlando Computer User Group**

### Mozilla, The Browser

I've been meaning to write about Mozilla for a while, but never got around to it. However, it is becoming more popular and I see more and more written about Mozilla, in fact I even have a review for it on my Web page. It is not quite as full featured as the IE and Netscape, but it does some things those do not. Best of all, it's free so what do you have to lose. It's also said to be faster since the code is lean and mean. It is skinable and it kills all those popups.

A few Web pages may not view as well, but I'm told there is a lot to like about Mozilla. Get it at <http://www.cnet.com/software/0-3227884-8-20005816-2.html?tag=st.sw.3227884-8-20005816-1.arrow3227884-8-20005816-2> where there is also a review.

### What's In Your House?

Many of us talk about making up a personal inventory, but just never get around to it, but in case you do take the time to do it, here is a great software called "My Stuff 1.5" for doing the job. It is available at <http://www.contactplus.com/products/freestuff/mystuff.htm> and it's a freebie.

The download is 4 MB. You can even see "page previews" there so you can get a good look at it. Even so, at no cost, just go ahead and download it and give it a try. No loss except your time if you don't like it. My thanks to Jerry Wonderly of Dayton Microcomputer Association for finding this for their members. Do yourself a favor and get this done, but don't store the record in your own house. Guess why!

### Dear IRS, Please take it easy on me — Yeah Right!

I should have written about Tax Act last month, but it's still not too late. It's a free product to use for your personal income tax. You can go to <http://www.taxact.com> and do your taxes at no cost in two ways. If you have a dialup connection, you may like the method where you do not have to download anything, but instead, do your taxes right on their web site for free as you answer questions for the information. You can also download their free software and go ahead and fill it in at home. It interviews you as you go through it, asking you questions of all types trying to get your information and data for computing your income tax. It takes a bit of getting used to and I made mistakes last year that I had to go back and fix because of assumptions, but it does work.

I used it last year and was a bit agitated by its constantly bugging me to buy their better version. Actually, I did eventually purchase the \$9.95 upgrade, but mostly because it included one free electronic tax filing. Taking that into consideration, the upgrade also has some comparison features included among other things and would actually only cost me \$2.00 after doing the e-file since an e-file cost you \$7.95 using the free version. One shortcoming I felt it had was if you had any complicated stock transactions. I finished mine after a couple of e-mails back and forth with the tech people at Tax Act. They answered my questions the next day and didn't quite understand



### Washington Area Computer User Group (WAC) Meetings

WAC Meeting will be held on February 21, 12:30 PM to 3:30 PM. at the Fairfax County Government Center, 12000 Government Center Parkway, Fairfax, VA

You do not need to be a member to attend. For more information on WAC meetings and events, call the WAC AnswerLine (voice) at (703) 370-7649. Also see WAC's Web Site at

<http://www.wacug.org/>

my question the first time. When I finally was satisfied and sent my e-filing, they responded by telling me it had been received and letting me know the approximate date my refund would be deposited to my account. They were correct; it took ten days. I sent them a complaint and they may have improved the stock transaction part. It's free so what could it hurt if you don't like it. Remember that my review for Tax Act on my Web site is a year old and I assume there are improvements by now.

### Free Antivirus Software

AVG antivirus software by Grisoft has a free version and I understand it is pretty good. I have seen it recommended in several user group newsletters, but I've not tried it myself. You can get it at <http://www.grisoft.com>. A word of warning though — don't try to have more than one AV working at the same time because they often tend to clash.

### Print Your Screen, Or Any Part, OK?

PrintScreen by Gadwin lets you capture any part, or your entire screen for printing, copying to the clipboard or saving it into a file. This is a very handy utility and can be had at <http://www.gadwin.com/> download. You can choose from six different image formats and they can be resized. Their Web site says PrintScreen 2.0 is an easy-to-use FREEWARE utility.

This column is written to make user group members aware of special offers or freebies I have found or arranged, and my comments should not be interpreted to encourage, or discourage, the purchase of any products, no matter how enthused I might sound. Bob (The Cheapskate) Click [Bobclick@mindspring.com](mailto:Bobclick@mindspring.com). Visit my Web site at <http://www.dealsguy.com> for past columns and many interesting articles I have taken from various users group newsletters.



*(Continued from page 11)*

### Future Features

I've been having some dialog with Jim Voelker, and I listed below a few of the things that I'd like to have him consider in the future.

An included utility to help the users rename images (using a 4-digit numeric string) to set the desired order.

The ability to use not only background music, but voice clips, and have independent control of both. Various of my present shows in other programs allow the use of voice clips to be inserted when a given slide appears, and temporarily suspend the background music, and then have the music restart when the clip is finished, or when the next slide appears.

Right now, the "menu" that appears when there are multiple shows involved is a file listing, via a Windows file manager-type display. I suggested that a listing that wasn't so generic would be more attractive.

### Conclusion

The "future features" noted are absolutely not needed to make this program a very worthwhile addition to anyone's computer. The combination of present features, price, and user friendliness make this program a must-have in my book.

So, visit Jim's site, and get more information, if needed, and definitely consider registering this program. It's a winner! I'd appreciate any feedback you might have along the way. I can be reached at: [ronhirsch@adelphia.net](mailto:ronhirsch@adelphia.net).

Reprinted from the August 2003 issue of Boca Bits, the monthly magazine of The Boca Raton Computer Society, Inc. (BRCS). Ron Hirsch is a regular contributing editor to Boca Bits. There is no restriction against any non-profit group using this article as long as it is kept in context with proper credit given the author. This article is brought to you by the Editorial Committee of the Association of Personal Computer User Groups (APCUG), an international organization of which this group is a member.

## Inhuman Computers

by Elizabeth B. Wright, Oklahoma City PCUG

Older-model automobiles, airplanes and boats could be cajoled, sweet-talked and occasionally reasoned with. That's why many people gave their cars, aircraft and water craft names (usually women's names) and made them part of the family. But that is mostly because they operate by virtue of the internal combustion engine principle. (I'm talking about the days before computer chips replaced some of the mechanical functions of vehicle operations.) Also cars often take on the personality of the owner, much like pets do.

Computers, on the other hand, have no soul, no compassion, and certainly no desire to please. The computer is amoral (not immoral, except in the hands of some people), totally insensitive to invective or other forms of oral communication, cannot be humiliated by ridicule or strengthened by praise, and most certainly doesn't respond to human reasoning. The occasional kick only makes them more intransigent (and, they break, easily).

But your computer can sometimes be tricked. Since they have no sense of humor or sense of belonging, they do not understand that they can be replaced easily, usually by a superior, yet cheaper, machine. So they are not really trying to cooperate when you succeed in outsmarting them, they just honestly don't know any better.

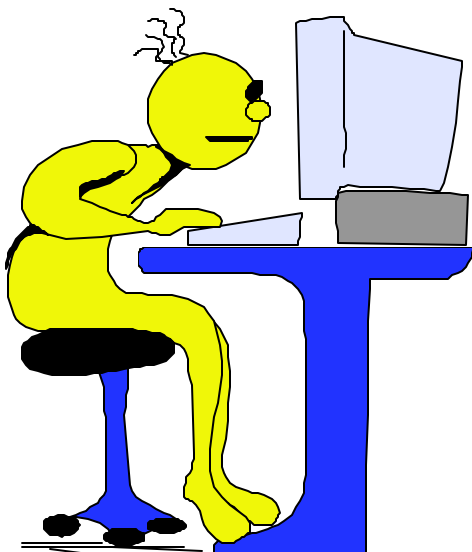

Computers crash in ways that lead you to believe there is absolutely no way to recover any of your most valuable information. But one of the best tricks of the trade is to just (in the words of a long ago Oklahoma City weatherman) "turn the d\_\_n thing off". Given an overnight rest, many computer crashes can be mitigated, at least for the short term, long enough to move your stored data to some other media, or even to another computer. Along with giving the machine an overnight rest, it is often advisable to unplug it from the electrical outlet after turning it off, to further enhance the rest period. I am not suggesting that this is an infallible procedure, but I personally have had it help more than once, and have talked with a lot of other people who have had similar luck.

Another trick, and this one is rather obvious, is to have more than one hard drive. Storing your important documents on both drives helps with recovery should one drive fail. Again, the computer doesn't care whether it has one hard drive or a dozen. As long as it knows the drives are there, you can pretty much do your own thing. You wouldn't necessarily have two engines in your car, but two or more hard drives is a good idea. Help is out there to recover your data if one of the drives is still functioning, even if it isn't the boot drive.

Trick number three: Although the computer doesn't tell you so, it does like a cool and hopefully dust-free environment. It doesn't know it needs this, but when it decides to roll over and play dead, it is often because it is suffering from heat exhaustion. The newer the computer, the hotter it will get while it is on. Since many people now leave their machines running 24/7, the heat problem can become critical. Internal fans are the beginning, but keeping the computer in a relatively cool part of the room is also important. Keeping it in the vicinity of the heat ducts during cold weather is not a good idea. That just causes the internal cooling equipment to perhaps not be able to handle the job adequately.

*(Continued on page 16)*



(Continued from page 1)

power companies. Your GameBoy is guaranteed to have eaten or worn down your last batteries that fit in the portable radio when the lights dim and flicker out.

We used a battery-powered TV sparingly during Isabel. It required 10 "C" cells, and while it does a respectable job as B&W TV and FM / AM radio, the battery pile weighs as much as the TV/radio unit. For that matter, so does the "wall wart" for those times when you have power. This unit was made by GPX, and cost about \$30 at Hecht's after redeeming a manufacturer's coupon. See: [http://www.gpx.com/pages/products\\_ind.php?id=105&flag=cat](http://www.gpx.com/pages/products_ind.php?id=105&flag=cat)

So, what's the solution for those times with no battery availability? Picking up on the BayGen Free-play radio of the early '90s, Grundig offers the FR200 AM/FM Shortwave radio, complete with crank for dynamo operation. Turn the crank handle for 90 seconds to charge the internal NI-MH battery pack, and you've got about an hour's worth of play-

ing time at reasonable volume. The radio includes a little flashlight bulb (and a spare!), so you can pick your way around furniture — once you find the radio, of course.

Also included is a surprisingly substantial case and carry strap, but you've got to remove the radio from the case to operate it. The radio can also be operated from three "AA" cells, or a 4.5V DC adapter (not included). Tuning is of the manual slide rule variety, with a fine tuning knob, although the ratio isn't substantially different from the main tuning knob. And, you don't have to order from the paper with the big shipping and handling fee — Radio Shack carries the FR200 for \$39. For more information, see: <http://www.grundigradio.com/asp/Products.asp?productname=fr200&action=overview>



## NCTCUG Information

NCTCUG, Post Office Box 949, Arlington VA 22216

Club Information call: 301-577-7899

Web Site: [www.nctcug.org](http://www.nctcug.org)

### Officers and Directors

All officer terms expire 2003

President	Jim Rhodes	703-931-7854
1st VP	Ron Schmidt	301-577-7899
2nd VP	Roger Fujii	703-280-1243
Treasurer	Paul Howard	703-860-9246
Secretary	Roger Arnold	301-946-7770

Director: term expires

Bob MacFarlane	2004	703-533-0259
Blair Jones	2004	202-362-7344
John Keys	2004	703-451-0896
Nick Wenri	2004	703-759-3938
Fred Cook	2005	703-921-1749
JJ Davies	2005	703-379-9222
Sy Fishbein	2005	703-536-5894
Dean Mires	2005	301-931-2400

### Article Submissions

Articles, helpful hints, and other items of interest to readers of the NCTCUG Journal are always welcome and will be published as soon as possible after submission. Priority is given to members' contributions. Items may be submitted via modem to the BBS or on diskette. Submissions to the BBS should be uploaded to the Newsletter Conference and a message left for the Editor. Files should be straight ASCII, unformatted, with CR only at end of paragraphs; no indents for paragraphs should be used. Preferred format for diskettes is MS-DOS 3½ 720k or 1.44Mb. Diskettes in other formats may be submitted but there will be a considerable delay in processing. If absolutely necessary, items may be submitted in hardcopy only but these will also meet with delay.

### Membership Policy

The National Capital Tandy Computer Users Group, Inc. is a non-profit [501-c(3)] organization founded in 1977 to educate users of all Tandy computers and MS-DOS compatible computers. Membership dues are \$25.00 (U.S.Funds) per year, with a \$5 surcharge for international mail. Membership in NCTCUG includes membership in all SIGs, access to the BBS and software libraries, and subscription to the Journal published 10 times per year. Applications may be obtained at any club meeting, by downloading from the BBS, by calling one of the officers or board members, or by writing to the club. A sample newsletter, membership application and related information may be obtained by enclosing \$1 and mailing your request to Jim Rhodes, 201 S. Kensington Street, Arlington VA 22204.

### Advertisement Policy

Members' advertisements: Ads are accepted from members for non-commercial purposes at no charge. Copy should be sent to the Editor in the same format as article submissions. Commercial Advertisements: Ads are accepted from commercial advertisers at the rate of \$60 per full page, per appearance, with discounts for multiple insertions. Smaller ads are priced accordingly. Payment for ads must be made in advance of appearance. Advertisers must supply a permanent address and telephone number to the editor.

### Reprint Policy

Permission to reprint articles from the NCTCUG Journal is given to school, personal computer club, and nonprofit organization publications, provided that: (a) NCTCUG Inc. receives a copy of the publication; (b) credit is given to the NCTCUG Journal as the source; (c) the original author is given full credit; and (d) the article author has not expressly copyrighted the article. Recognition is one means of compensating our valued contributors

### Newsletter Staff

Editor  
Blair Jones 202-362-7344  
[bjones44@bellatlantic.net](mailto:bjones44@bellatlantic.net)  
Exchange Newsletter and  
Articles Editor  
Ron Schmidt 301-577-7899

### COMPUCENTER BBS

Is no longer in operation. It has been replaced by the 'compucenter' mailing list at <http://groups.yahoo.com/>

**If you are moving**  
**Please send your change of address to the club PO box as soon as possible to avoid missing issues.**

*Thank You!*

(Continued from page 14)

Trick number four: Dirt and other stuff (bugs for example) can get into the computer case; it doesn't hurt to have someone who knows how to do it clean out the insides of the shell. I don't advise doing this if you aren't really technically adept as those small parts are so sensitive that you could do a lot more damage than just leaving it dirty.

Trick number five: In spite of how you might think you are communicating with your computer with fancy screen icons, word commands and pictures, the computer only knows two commands. They are "on" and "off". Most of the on/off switches are in those tiny chips, but the more you can think in terms of how little the computer actually understands, the more you can see why confusing it with conflicting programs can overwhelm its ability to function. More and more of us are wanting to use the latest and most sophisticated programs on the market, but just be aware that each new addition has the potential to cause your computer to become unstable. **PLAN AHEAD!! BACK UP YOUR WORK!!**

Elizabeth Wright is a member of the OKCPCUG and a regular writer for the eMonitor.

There is no restriction against any non-profit group using this article as long as it is kept in context with proper credit given the author. The Editorial Committee of the Association of Personal Computer User Groups (APCUG), an international organization of which this group is a member, brings this article to you.

NCTCUG, Inc.  
P.O. Box 949  
Arlington VA 22216

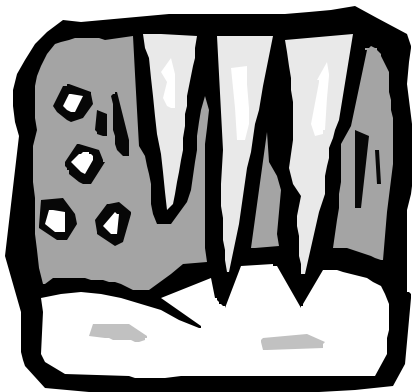

**First Class**

**February 2004**

1st Wed. (2/4) **7 p.m.**  
Virginia General Meeting

4th Wed (2/25) **7 p.m.** Internet SIG  
No meeting Christmas Eve!  
Happy Holidays

3rd Monday (2/16) **7 p.m.**  
Board of Directors

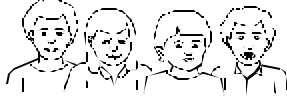

All meetings are at **Carlin Hall**, 5711 S. 4th St., Arlington VA: East off of Carlin Springs Rd, just south of Arlington Blvd/Route 50.

